



USER MANUAL – EN

IN 8947 Vibration Plate inSPORTline Charles



CONTENTS

- INTRODUCTION 3
- PARTS 3
- EXPLODED VIEW 4
- PARTS LIST 5
- ASSEMBLY 8
- OPERATION INSTRUCTIONS 9
- SAFETY CAUTIONS 11
- MAINTENANCE 13
 - HOW TO STORE 13
 - SELF-MAINTENANCE 14
 - CLEANING 14
- PRODUCT SPECIFICATION 14
- TERMS AND CONDITIONS OF WARRANTY, WARRANTY CLAIMS 14

INTRODUCTION

Thank you for purchasing vibration plate. Please read the operation manual thoroughly before you begin operating the machine. This operation manual should be kept available for future reference after you have read it through.

SC class (according to EN957) for home and club use

Our company has the absolute right to alter the design pictures and material color without prior notice. Design, pictures and material color seen in this manual is solely for illustration purpose.

PARTS

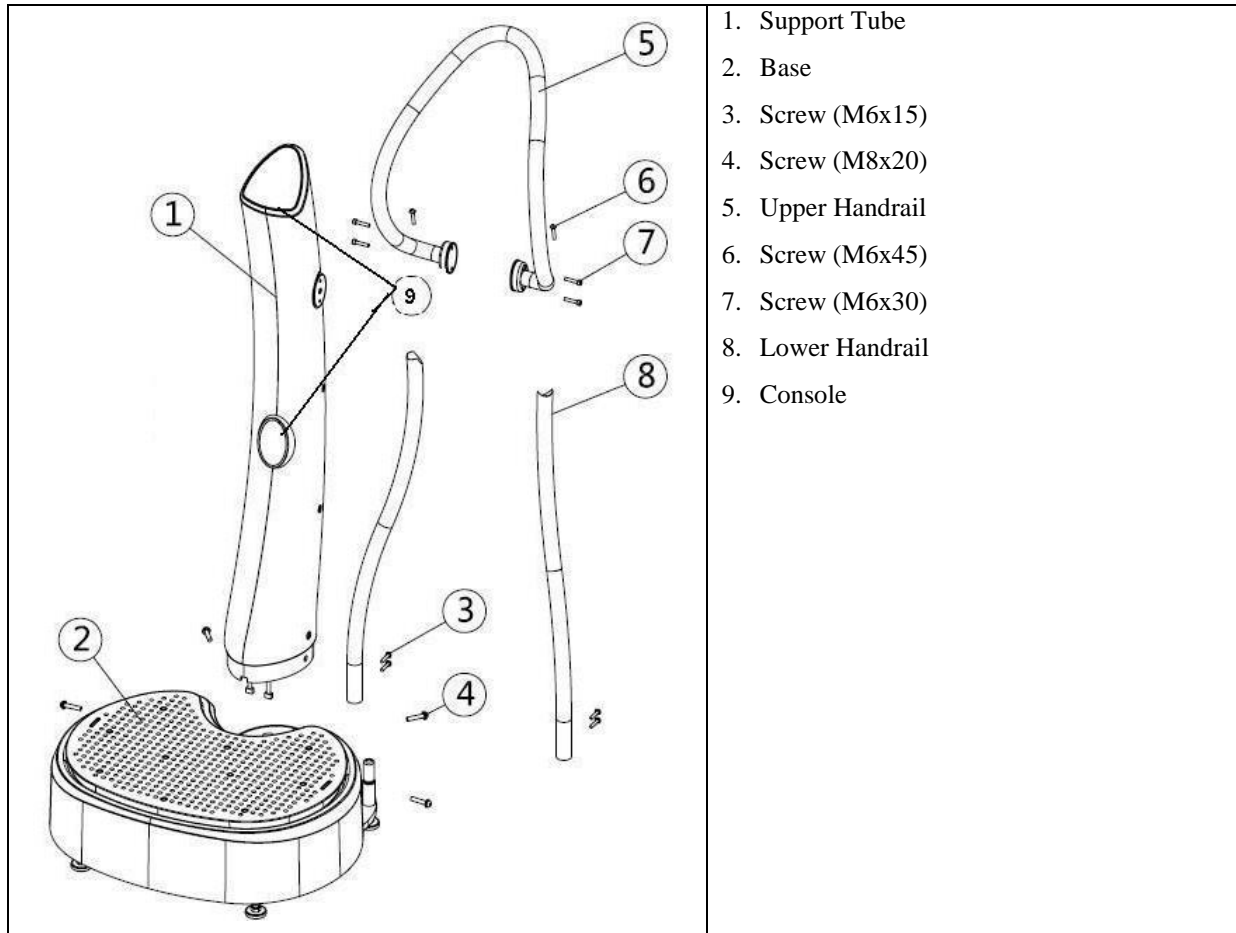

EXPLODED VIEW

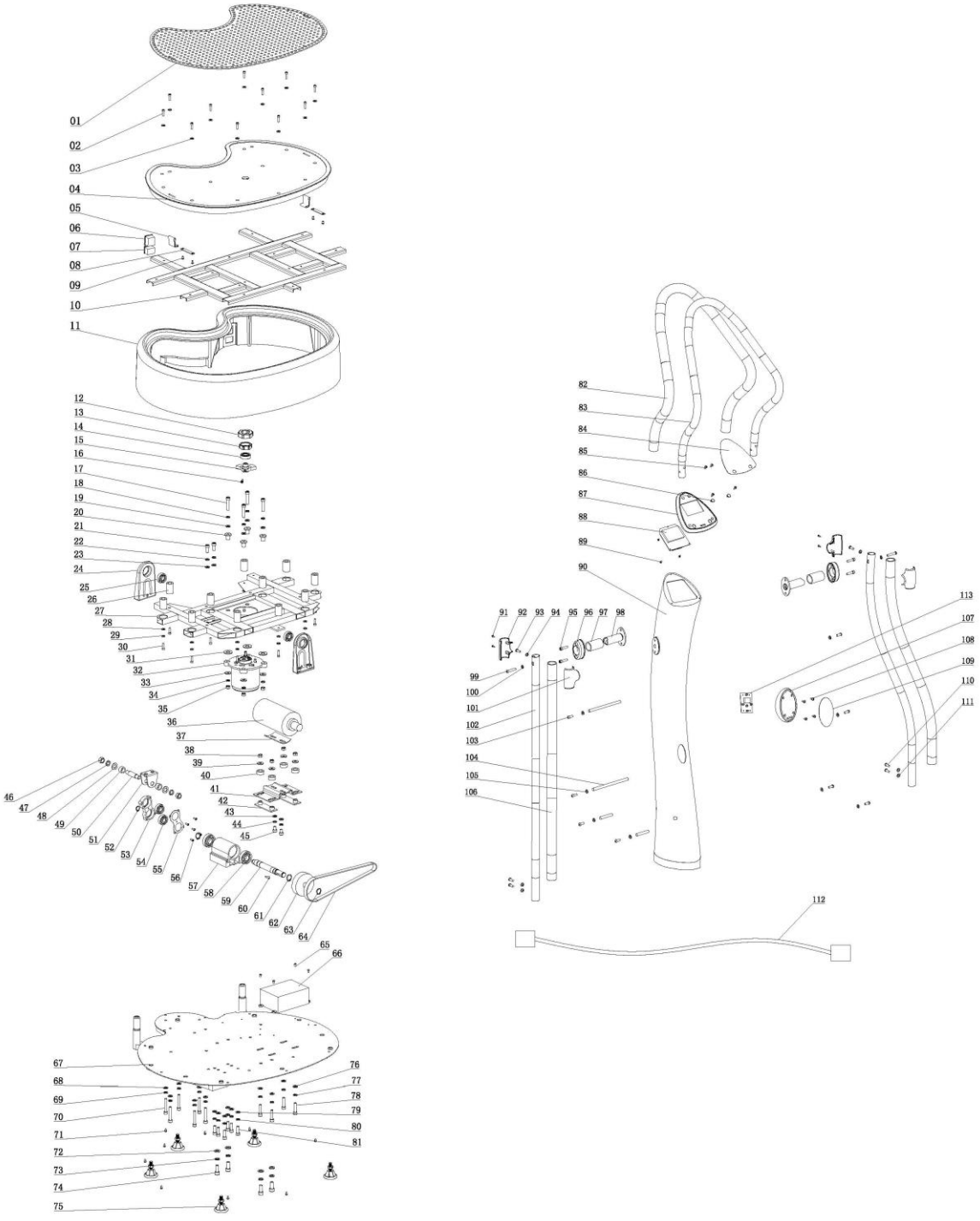

PARTS LIST

No.	Name	Qty
1	Foot skin	1
2	Inner hexagon cylindrical screw	11
3	Washer	11
4	Footplate	1
5	Ornament of straps	2
6	Switch	1
7	Socket	1
8	Metal clip for fixing ornament of straps	2
9	Hexagon nipples	4
10	Strengthening rod components	1
11	Base casing	1
12	Rubber sleeve	1
13	Bearing sleeve	1
14	Deep groove ball bearing	1
15	Eccentric block	1
16	Inner hexagon cylindrical screw	1
17	Inner hexagon cylindrical screw	4
18	Spring washer	4
19	Washer	4
20	Insulation sleeve of spiral motor	4
21	Inner hexagon cylindrical screw	2
22	Spring washer	2
23	Washer	2
24	Footplate bracket assembly	2
25	Deep groove ball bearing	2
26	Vibration absorber	11
27	The whole footplate	1
28	Washer	11
29	Spring washer	11
30	Inner hexagon cylindrical screw	11
31	Epoxy washer	4
32	Spiral motor	1
33	Big washer	4
34	Spring washer	4
35	Hexagon nipple	4

36	Oscillation motor	1
37	Motor insulation pad	1
38	Hexagon nipple	4
39	Big washer	4
40	Insulation washer of motor seat	4
41	Motor seat	1
42	Insulation pad of motor seat	2
43	Washer	4
44	Spring washer	4
45	Inner hexagon cylindrical screw	4
46	Hexagon nipple	2
47	Spring washer	2
48	Flat washer	2
49	Locating sleeve	2
50	Axle of connecting rod	1
51	Bracket of connecting rod	1
52	Clamp spring of axle	1
53	Connecting rod	1
54	Deep groove ball bearing	2
55	Connecting rod cap	1
56	Phill disk head screw	5
57	Aluminum bearing seat	1
58	Deep groove ball bearing	2
59	Woodruff key	1
60	Eccentric shaft	1
61	Clamp spring of axle	2
62	Belt pulley	1
63	Clamp spring of axle	1
64	Motor belt	1
65	Phill disk head screw	4
66	PCB controller	1
67	Metal base plate	1
68	Washer	6
69	Spring washer	6
70	Inner hexagon cylindrical screw	6
71	Phill disk head self-tapping screw	9
72	Washer	4
73	Spring washer	4

74	Inner hexagon cylindrical screw	4
75	Adjustable feet	5
76	Washer	4
77	Spring washer	4
78	Inner hexagon cylindrical screw	4
79	Washer	6
80	Spring washer	6
81	Inner hexagon cylindrical screw	6
82	Upper handrail protection foam	1
83	Upper handrail	1
84	Main control panel sticker	1
85	Phill disk head self-tapping Screw	4
86	BMI sensor chip	2
87	Main control Panel	1
88	Display PCB	1
89	Phill disk head self-tapping screw	3
90	Column	1
91	Phill disk head self-tapping screw	4
92	Handrail front plastic cover	2
93	Inner hexagon disk screw	2
94	Flat washer	2
95	Inner hexagon cylindrical screw	4
96	Handrail flange plastic cover	2
97	Handrail flange protection foam	2
98	Handrail flange locating rod	2
99	Inner hexagon disk screw	2
100	Flat washer	2
101	Handrail back plastic cover	2
102	Lower handrail tube	2
103	Inner hexagon disk screw	8
104	Column location pin	4
105	Washer	8
106	Lower handrail protection foam	2
107	Lower control panel	1
108	Phill disk head self-tapping screw	4
109	Lower control sticker	1
110	Inner hexagon disk screw	4
111	Washer	4

112	Plug	1
113	Column LED PCB	1

ASSEMBLY

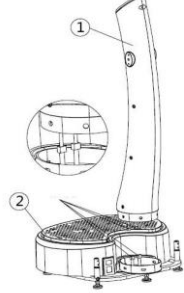
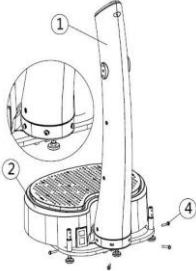
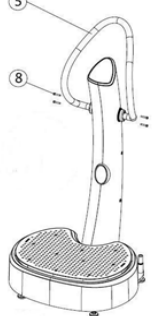
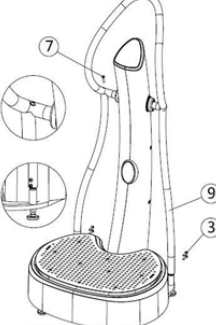
<p>STEP 1: Take out the support tube (1) and main base (2) from packing carton. Connect the upper and lower signal cable.</p>	
<p>STEP 2: Put the support tube (1) into the base (2). Lock them with screws (4) and install the feet cushion.</p>	
<p>STEP 3: Install the upper handrail (5) on the support tube with screw (8).</p>	
<p>STEP 4: Take out lower handrail (9) and install with screw (3) and (7) as picture.</p>	

This is final assembled picture.

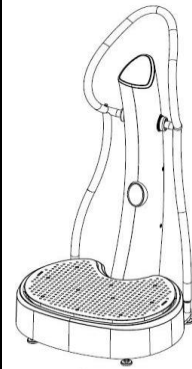



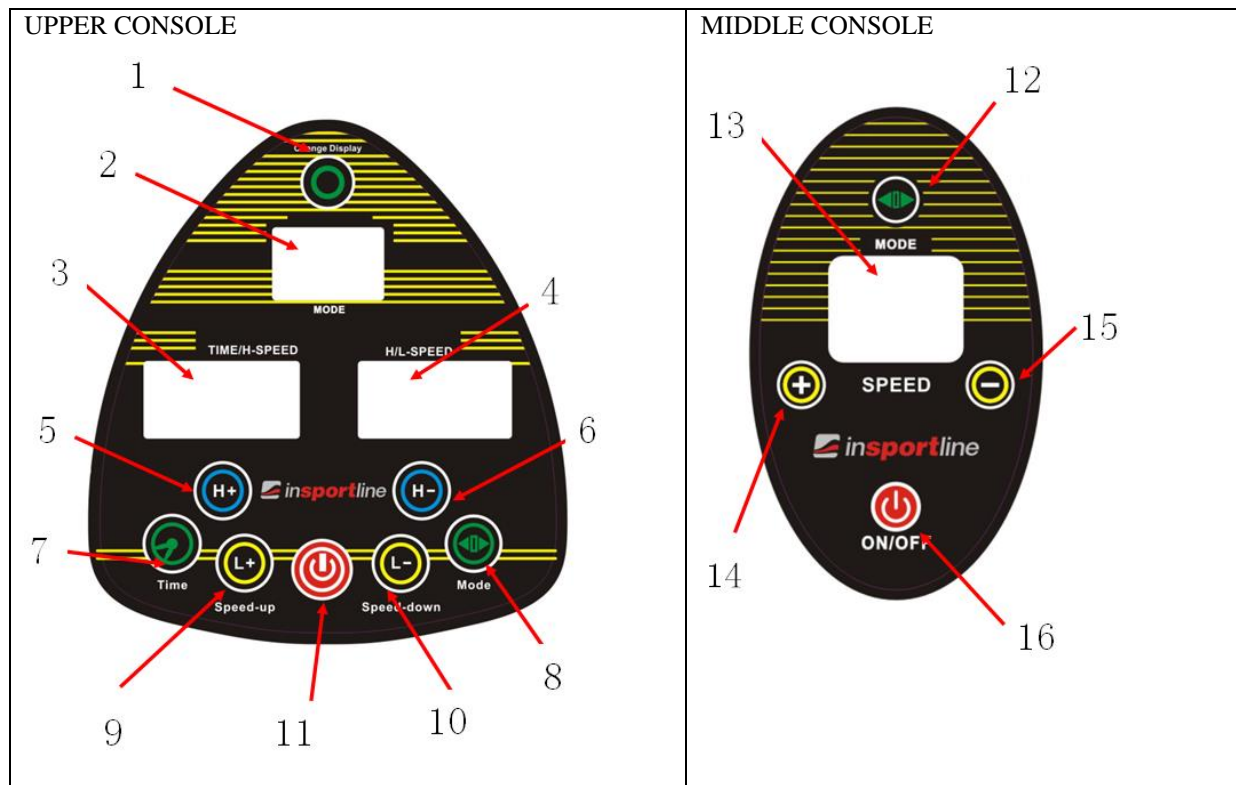



OPERATION INSTRUCTIONS







UPPER CONSOLE OPERATION

 <p>1.</p>	<p>Press this button to switch the time or speed display during the machine.</p>
<p>2. MODE window</p>	<p>Display the current mode of machine, manual or automatic.</p>
<p>3. TIME / H-SPEED window</p>	<p>Display the time countdown or oscillation speed. Switch the display mutually.</p>
<p>4. H/L SPEED window</p>	<p>Oscillation or spiral vibration speed display, switch the display mutually.</p>

5.  Oscillation speed +	In manual mode, press this button to increase the oscillation speed, the speed range is 1 to 60 level.
6.  Oscillation speed -	In manual mode, press this button to reduce the oscillation speed, the lowest is 1 level.
7.  Time	Set the running time of the machine. This is the total time the machine is running. When the running time reaches the set value the machine will automatically stop running. Setting method: The default time is 10 minutes. When you select the manual mode, press this button before the machine is running, then press button “H+” or “H-“ to increase or reduce oscillation running time, press “L+” or “L-“ to increase or reduce the spiral vibration running time. After setting the time, press Start/Stop button, the machine run at the current set time, the machine automatically stops after the countdown time.
8.  MODE	Loop select during “HL, P1, P2, P3”. “HL” is manual mode, P1\ P2\ P3 are automatic mode. In manual mode, manually increase or reduce the speed levels; In automatic mode, the machine runs at pre-setting time and speed. In standby state, select the mode, then press button 11 or 16 to start-up, the machine will run at the current mode.
9.  Spiral vibration speed +	In manual mode, press this button to increase the spiral vibration speed, the speed range is 1 to 60 level.
10.  Rychlost spirálních vibrací -	Spiral vibration speed down: In manual mode, press this button to reduce the spiral vibration speed, the lowest is 1 level.
11.  Start/Stop	Start or Stop the machine.

MIDDLE CONSOLE OPERATION

12.  MODE	Loop select during “HL, P1, P2, P3”, the function are same with upper console.
13. Display window	Display the current mode or speed or time.
14.  Speed +	In manual mode, increase the oscillation & spiral vibration speed at the same time.

 15. Speed -	In manual mode, reduce the oscillation & spiral vibration speed at the same time.
 16. ON/OFF	Start or Stop the machine.

AUTOMATIC PROGRAMS

P1:

Oscillation:	30 34 38 42 46 50 54 58 54 50 46 42 38 34 30 26 22 18 14 10 6 2 6 10 18 22 26
Vibration:	30 26 22 18 14 10 6 2 6 10 14 18 22 26 30 34 38 42 46 50 54 58 54 50 46 42 38 34

Time Interval: 5 seconds

P2:

Oscillation:	5 10 15 20 25 30 35 40 45 50 55 60 55 50 45 40 35 30 25 20 15 10 5
Vibration:	Stop
Oscillation:	Stop
Vibration:	5 10 15 20 25 30 35 40 45 50 55 60 55 50 45 40 35 30 25 20 15 10 5

Time Interval: 2 seconds

P3:

Oscillation:	2 40
Vibration:	40 2

Time Interval: 5 seconds

SAFETY CAUTIONS

Please follow the warnings and cautions said below strictly. This will prevent to damage of your machine or any harm to your body or any lose which caused by any improper use of the machine.

When use the machine, please comply to the instruction to operate.

- Please make sure that the power plug does not get pressed by the side portion of the machine.
The power plug might get damaged leading to electrocution or fire.
- Use the power outlet for the machine only.
Connecting multiple products to an outlet might lead to fire. Fuse might get damaged or the product may not function.
- Please remove dirt on the power plug using dry clothes.
Dirt and abnormal connection might lead to fire.
- Leave 20cm of gap from the wall when installing the machine.
Good air circulations will prevent the product from malfunctioning.
- Please install the product in solid and horizontal ground.
Noise and vibration might be created when the ground level is not horizontal. Please adjust the machine when the ground is not even.

- After using the machine, please press the Stop button. Step down from the machine when the machine stops completely.
Stepping down during run state might lead to physical injuries.
- Please unplug the power plug when the product is not in use.
This will prevent unnecessary wastage of electricity and may prevent fire.
- Please do not run on top of the machine when the product is in use.
The product might get damaged.
- Old people and children should be accompanied by guardians in using the machine.
Physical injuries might be caused.
- The machine cannot take load of more than two people.
The machine might get damaged.
- Before cleaning, remove any water particles using dry clothes to prevent water particles entering into the machine.
Water particles will weaken the insulation will lead to electric leakage and fire and easy to rot the machine.
- Please clean the surface of the machine using proper cleaners suitable for the material.
Please wipe the surface with dry clothes when wet towel had been used to clean the surface.
- Please clean and dry the machine before storing the machine for a long time.
Please clean the surface with dry clothes before storing to prevent corrosion.
- Please do not unplug and plug the power plug with wet hands.
It might lead to electrocution
- Do not band the power cord and avoid the power cord from getting damaged by heavy items.
When damaged, it might be lead to fire.
- Please do not use damaged power cord or plug.
It might lead to fire or electrocution.
- Do not install the machine in wet place or near to water.
It might lead to electric leakage. The machine may get corroded when used in wet place or place nearby water.
- Please do not stock items on top of the plate.
It might lead to electrocution or fire and may damage the electric circuit.
- Do not sprinkle water or clean the machine using gasoline, benzene, thinner or chlorine.
There is danger of getting electrocution or catching fire. It also might damage the electronic circuit.
- Please remove the power plug before cleaning
For prevention of electric leakage.
- When the machine creates smoke or burning smell, remove the power cord immediately and stop exercising.
It might lead to fire or electrocution.
- Please do not disassemble, repair or modify the machine if you are not professional.
Non-compliance will lead to product damage or financial damage due to fire or malfunctioning of the machine.

If you are under medical treatment or any of the following symptoms. Please consult your doctor before use.

- Epilepsy
- Diabetes
- Heart and vascular disease
- Slipped disc or had Back/Spine Surgery
- Knee and hip implants
- Pacemaker
- Recently insert IUD, Metal pins
- Tumor
- Recent infections
- Recent operative wounds
- Pregnant women
- Severe migraine

TIPS

It is advisable to drink 500ml lukewarm water before use in order to eliminate the toxic wastes. Drink 3000ml of water daily for a healthier lifestyle as it can revitalize your energy in your body. Water can benefit your body as follows:

- Helps prevent indigestion
- Reduce sickness especially in the kidney
- Enhance metabolism rate
- Improve blood circulation and prevent heart disease
- Strengthen your immune system
- Reduce pressure and stress
- Prevent fatigue and increase stamina in the body
- Enhance your skin texture for a freshness look

MAINTENANCE

HOW TO STORE

1. Do not store the Vibration Plate:
 - Near heat or open flame.
 - Under the direct sunlight for a long period time.
 - Harmful gas and dust, especially humidity.
2. Keep the Vibration Plate:
 - Usage temperature: 0-35°C.
 - Keeping temperature: 5-50°C.
 - Humidity: under 40-80%.
3. If the Vibration Plate is not use for long period of time, cover it with a piece of clean to protect it from dust.
4. Do not store the Vibration Plate under direct sunlight or at places of high temperature.
5. Do not coil the wire cord as it may cause malfunction to the machine.

SELF-MAINTENANCE

1. Before cleaning, ensure that the main switch is turned off and AC plug is removed from the electrical outlet.
2. Do not using the Vibration Plate too long for the first time.
3. Switch off power and remove the plug from the socket every time after use.
4. Do not use this machine in wet areas such as bathroom, swimming pool or spa.
5. Do not use it when there is too much dust, oil, smoke or caustic gas.
6. Avoid damaging the surface of the Vibration Plate surface with heavy object, by knocking hard, scratching with force.

CLEANING

Using corrosive cleanser is prohibited. Do not use benzene or thinner to clean or spray insecticide on the machine.

PRODUCT SPECIFICATION

Input Voltage	220V-240V/50Hz
Oscillation Motor	500W
Vibration Motor	300W
Speed Range	1-60 level
Display	Program / Time / Speed 3led
Dimensions	730mm (L) X 700mm(W) X 1450mm (H)
Load Weight	120KGS
Net Weight	36KGS
Gross Weight	40KGS

**SEVEN SPORT s.r.o.**

Sídlo: Bořivojova 35/878, 130 00, Praha 3, ČR
Centrála: Dělnická 957, 749 01 Vítkov
Reklamace a servis: Čermenská 486, 749 01 Vítkov

IČO: 26847264
DIČ: CZ26847264
Telefon: +420 556 300 970
Mail: eshop@insportline.cz
reklamace@insportline.cz
servis@insportline.cz
Web: www.insportline.cz

SK**inSPORTline s.r.o.**

Centrála, reklamácie, servis: Električná 6471, 911 01 Trenčín, SK

IČO: 36311723
DIČ: SK2020177082
Telefón: +421(0)326 526 701
Mail: objednavky@insportline.sk
reklamacie@insportline.sk
servis@insportline.sk
Web: www.insportline.sk

Date of Sale:

Stamp and Signature of Seller: