



**USER MANUAL – EN**

**IN 7832 Children's Bike KAWASAKI Moto 12"**

**IN 3567 Children's Bike KAWASAKI Shrimp 12"**

**IN 4171 Children's Bike KAWASAKI Buddy 14"**

**IN 1843 Children's Bike KAWASAKI Dirt 16"**

**IN 7834 Children's Bike KAWASAKI Moto 16"**

**IN 1842 Junior Bike KAWASAKI Rebel 20"**

**IN 7839 BMX Bike KAWASAKI Kulture 20"**

# CONTENTS

- COMPONENTS..... 4
- USAGE ..... 5
  - CHILDREN'S BIKES 12", 14", 16" ..... 5
  - CHILDREN'S BIKES 20", 24", 26" ..... 5
- INTRODUCTION..... 5
  - TIPS AND RECOMMENDATIONS..... 5
  - INFORMATION IN THIS MANUAL..... 6
  - TERMINOLOGY ..... 6
- SAFETY INSTRUCTIONS..... 7
  - CHOOSING THE BIKE SIZE ACCORDING TO THE CHILD'S AGE AND HEIGHT ..... 7
  - RECOMMENDATIONS/WARNINGS..... 8
- BEFORE FIRST USE ..... 8
- BEFORE EVERY USE ..... 8
  - INSPECTING THE WHEELS..... 9
- ASSEMBLY, MAINTENANCE AND SETTINGS ..... 13
  - TOOLS/TECHNICAL SUPPORT ..... 13
  - ASSEMBLY..... 14
  - SADDLE POSITION ..... 16
  - REFLECTORS..... 16
  - PEDAL ASSEMBLY..... 18
  - SADDLE ASSEMBLY ..... 18
  - BRAKE AND BRAKE CABLE ASSEMBLY..... 19
  - STEM AND HEADSET ASSEMBLY (4 BOLTS)..... 19
  - STEM AND HANDLEBAR ASSEMBLY (1 BOLT)..... 20
  - AFFIXING THE FRONT WHEEL TO THE FORK..... 21
  - BRAKE SYSTEM ..... 22
  - ADJUSTING THE REAR DERAILLEUR..... 25
- CHAIN..... 25
  - SHOCK ABSORBER WITH STEEL SPRING..... 26
  - TIRES..... 26
  - TIRE REPLACEMENT ..... 26
- TRAINING WHEELS ..... 27
  - AFFIXING THE TRAINING WHEELS ONTO THE BIKE..... 28
- REPAIRS AND MAINTENANCE ..... 28
  - SPROCKET-WHEEL/CHAIN..... 29
  - TIRES..... 29
  - WHEELS ..... 29

BEARINGS.....	29
LUBRICATION.....	30
ONE-PIECE CRANKS .....	31
CLEANING AND MAINTENANCE .....	31
STORAGE .....	32
TORQUE OF THE CONNECTING MATERIALS .....	32
RIDING RECOMMENDATIONS.....	33
SERIAL NUMBER .....	34
TERMS AND CONDITIONS OF WARRANTY, WARRANTY CLAIMS.....	34

# COMPONENTS

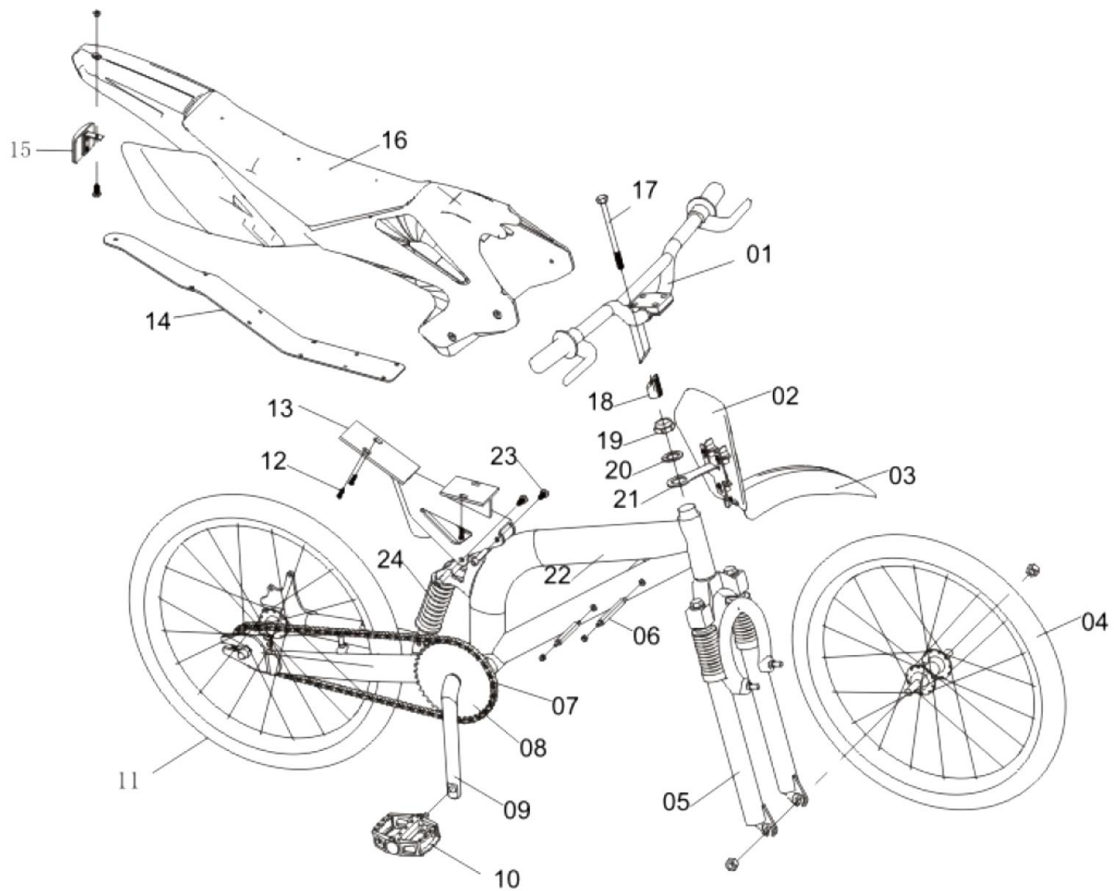

Picture includes all components mentioned in this manual.

1.	Handlebars	13.	Seat holder
2.	Protector with number	14.	Seat support
3.	Front mudguard	15.	Rear reflector
4.	Front wheel	16.	Saddle
5.	Front fork	17.	Stem screw
6.	Inner threaded casing	18.	Wedge
7.	Chain	19.	Headcap
8.	Chainring	20.	Cap
9.	Crank	21.	Front mudguard holder
10.	Pedal	22.	Frame
11.	Rear wheel	23.	Safety screws
12.	Bolt	24.	Frame suspension

The picture above is only illustrative.

**This manual only includes safety, use and maintenance instructions. Read the entire manual before using the bike for the first time and keep it safe for possible future use. Follow the instructions in this manual and be sure to tighten all connections correctly.**

By buying this product you take responsibility for your safety. The manufacturer, distributor, seller or the employees of the public services are not responsible for any injuries that might occur. Follow every safety precaution while riding the bike.

## **USAGE**

### **CHILDREN'S BIKES 12", 14", 16"**

The maximum seat height of bikes in this category is 435 – 635 mm. The maximum seat height is the measured vertical distance from the top of the saddle to the ground, provided the saddle is horizontally inclined and the seat post is set to its maximum possible height. These bikes are made for the most junior riders. Taking into account the probable skills and abilities of young children, the bikes are suitable mainly for flat and hard surfaces (playgrounds/training grounds). If you use the bike on public roads, you need to equip both the bike and the child with all necessary protective features. The weight limit for the 12", 14" and 16" children's bikes is 40 kg. The total weight (the rider + bike + baggage) should not exceed 50 kg.

### **CHILDREN'S BIKES 20", 24", 26"**

The maximum seat height of bikes in this category exceeds 635 mm. These bikes are made for young cyclists and can be used on every type of terrain. If you use the bike on public roads, you need to equip both the bike and the child with all necessary protective features. A certain skillset is required to control these models. The weight limit for the 20", 24" and 26" children's bikes is 90 kg. The total weight (the rider + bike + baggage) should not exceed 100 kg.

**CAUTION:** Only use this product for the purposes it was designed for. If you do not use this bike in a proper manner, you endanger yourself and risk a fall or a collision. If you ride the bike on difficult terrains, its components can be damaged, perhaps irreparably. Riding a bike with damaged components is dangerous and can lead to falls or collision. Only ride on a terrain the model of your bike is suited for.

## **INTRODUCTION**

### **TIPS AND RECOMMENDATIONS**

- Always wear a bicycle helmet that meets the local safety standards.
- Consult local legislature to find out up to what age are bicycle helmets compulsory.
- Make sure any parts of your body, clothes or other objects do not make contact with the sharp edges of the derailleurs, pedals, the chain or the training wheels.
- Always wear fitting shoes that do not slip from the pedals. Do not ride with unsuitable shoes.
- Wear visible clothes, if possible made of reflective materials or complemented with reflective straps.
- Learn how to use the bike thoroughly; consult the seller if necessary.
- Jumping, riding on a ramp, or riding through difficult terrain can damage the bike and cause a serious injury.
- Always inspect the bike before using it.

#### **Parental disclaimer:**

As a parent or a guardian, you are responsible for your child's activities and safety. It is your responsibility to ensure your child is properly instructed on how to use the bike. Take extra care to explain the brake system, especially if the bike has a coaster brake.

Parents and guardians are also responsible for choosing the correct bike size and ensuring the bike is in perfect condition. Some parents purposely choose bigger bikes for their children in an effort to save money. However, this is dangerous for the child as they cannot feel safe on an oversized bike that is hard for them to control. In such situations the risk of an accident increases. Most bicycle riding accidents happen to children. An oversized bike can also have negative effects on the growth of the child's bones and muscles, because it is impossible to set the seat correctly.

**INFORMATION IN THIS MANUAL**

- If you do not adhere to the instructions in this manual, you risk causing a fall, injury or material damage.
- Before using the bike, read the entire manual first.
- Keep this manual and in case the owner changes, hand it over along with the bike.
- If you find the instructions in the manual unclear or have additional questions, contact the seller.
- It is not the purpose of this manual to teach the user how to ride the bike or to improve their riding technique.
- Taking into account the variety of bicycle components, this manual does not provide information about every one of them.
- Always follow the seller's recommendations.
- Children's seats and carriers cannot be affixed to children's bikes.

**TERMINOLOGY**

**Orientation** – “left, right, front and rear” are described from the view of the rider

**Authorized dealer** – seller-approved manufacturer at the time of the purchase

**Authorized service** – after-sale service and maintenance.

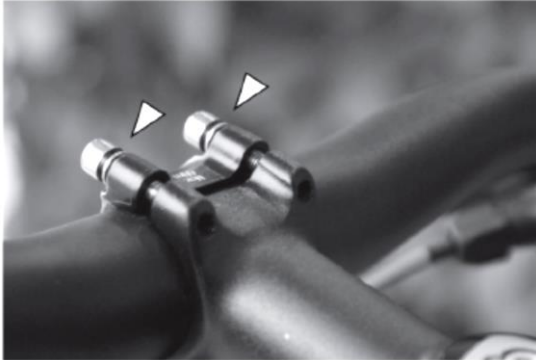
<p><b>Correct tightening</b> – situation where the screw head is tightened with the recommended amount of force (N m).</p>	
<p><b>Incorrect tightening</b> – situation, where the screw is not screwed fully or by the recommended amount of force (N m).</p>	

**Bar** – pressure unit, 1 bar = 100 000 Pa

**Psi** – American pressure unit, 1 psi = 0.06897 bar

**N m** – unit of torque

**Chainring** – the biggest chainring has the most teeth, the smallest has the least

**Sprocket-wheel** – the biggest sprocket-wheel has the most teeth, the smallest has the least

**Freewheel** – a system of several chain wheels

**Cassette** – part of the hub that holds the freewheel

## SAFETY INSTRUCTIONS

The rider should be able to keep balance on the bike and control the speed and direction with the provided braking system.

The size of the bike must complement the rider's stature. We recommend to choose the bike size according to the picture below. Standing astride the assembled bike, the rider's groin should not touch the top tube.

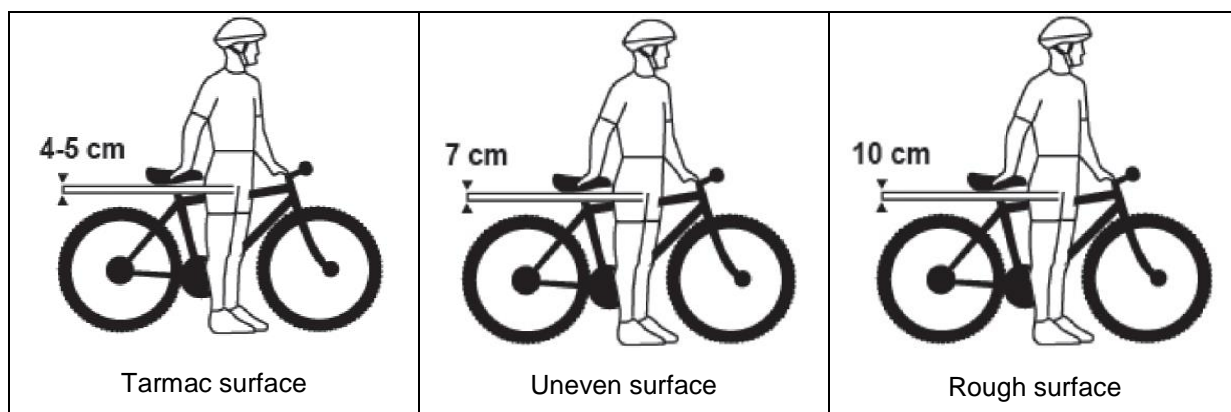

If you intend to use the bike on tarmac surfaces, the distance between the frame and your groin should be 4 – 5 cm. If you plan on riding on uneven terrain, the distance should be 7 cm. The optimal distance for riding on a rough terrain is 10 cm. Consult the bike size with the seller.

Do not forget that every road and pavement can have uneven parts, that can endanger the rider or damage the bike.

## CHOOSING THE BIKE SIZE ACCORDING TO THE CHILD'S AGE AND HEIGHT

Wheel diameter	Child's age	Child's height (cm)
12"	2 – 4	90 – 110
14"	3 – 5	95 – 115
16"	4 – 7	100 – 125
20"	5 – 9	105 – 135
24"	8 – 12	115 – 155
26"	9+	130+

While riding on public roads, make sure your bike is equipped with all the required components (brake system, reflectors, lights, bell, etc.). It is recommended to familiarize yourself with local legislation and consult the seller, if necessary.

Use a bicycle helmet. For maximum safety, choose the size and type according to the seller's recommendations (riding style is an important factor).

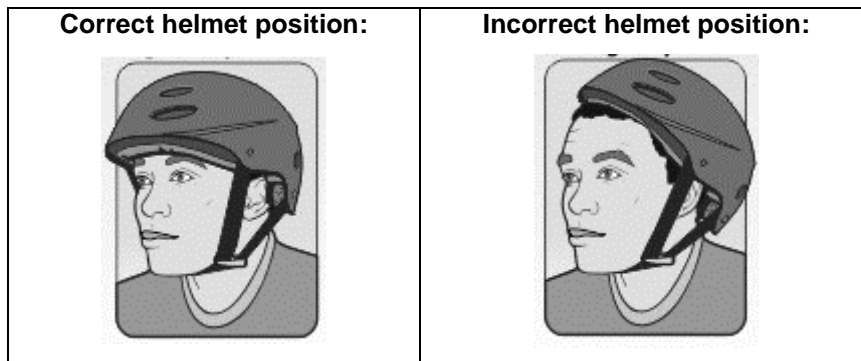

**DANGER:** If you decide to replace one of the components, it is recommended to use a component compatible with your bike. You may also want to consult the manufacturer. If you do not have sufficient experience or tools, contact the seller. Any amateur modifications may damage the bike and cause a serious injury or death.

## RECOMMENDATIONS/WARNINGS

- It is recommended to be extremely careful while riding on public roads (for better safety, always yield the right of the way).
- Keep in mind that the brake system's effectivity decreases on wet surfaces.
- Wear comfortable sportswear that cannot get caught in the moving parts of the bike.
- If you ride through worsened visibility conditions (dawn/twilight, at night or in bad weather), equip yourself with suitable reflective features and lights.
- Do not overload the bike. Consult the seller if necessary.
- Carefully read all instructions in this manual.
- Always wear a helmet while riding a bike.

## BEFORE FIRST USE

**DANGER:** If you use a bike not suited for riding on public roads, you risk falling, collisions, material damage or death.

Familiarize yourself with all the bike's features before using it for the first time. Try out the brake levers and see which wheel they control. For your safety, we recommend you try the brakes out while riding slowly at first, gradually picking up speed. The effectivity of the brakes increases with the intensity of the braking. If you use clipless pedals, practise fastening and unfastening them before riding the bike. Find a free space to practice, away from traffic or pedestrians. You'll be ready for the first ride only after inspecting the entire bike and reading through this manual.

## BEFORE EVERY USE

**DANGER:** If you use a bike without a complete or original components set, you risk an injury or material damage.

Make sure you remember the state the bike was in after the initial setting (by the seller) so you recognise any unusual changes. If you register such changes, take the bike to the seller for repairs.

Inspect the entire bike before every ride – the tightening of all connections, possible deformations, scratching or other mechanical damage.



## INSPECTING THE WHEELS

The wheel size depends on the purchased model:

1. 12" – wheel diameter: 203 mm + tire
2. 14" – wheel diameter: 254 mm + tire
3. 16" – wheel diameter: 305 mm + tire
4. 20" – wheel diameter: 406 mm + tire

### Wheel components:

- Hub
- Cassette (on the rear hub)
- Brake disc (if the bike has disc brakes)
- Spokes
- Rim
- Tire
- Tube (there are models without them)
- Rim protection strap

### INSPECTING THE CONNECTION OF THE WHEELS

Try to shake both wheels in every direction. The wheels cannot be loose and there shouldn't be any strange noises, e.g. creaking.

### INSPECTING THE RIMS

The wheels should not be dirty. They especially shouldn't be covered in oil. Remove oil stains immediately.

Check the rims for wear and replace them if necessary.



There should be no scratch marks or striations. Check the rim by tracing your nail along the brake area. If you discover any unevenness, consult the seller.

Lift up the front and rear wheel, spin them and check the distance between the rim and brake pads (rim brakes) or between the rim and the fork (disc brakes). Maximum deviation is 1 mm, otherwise it is necessary to centre the wheel.

You need specific tools and skills to inspect the bike as described above. If you are not experienced in this area or don't have the necessary tools, request assistance from the seller.

### INSPECTING THE TIRES



1. Valve position

**NOTE:** Doesn't apply to tires without tubes.

**DANGER:** If the valve nipple is not in a vertical position (doesn't line up with the position of the hub), there is a danger of it breaking off which would result in rapid pressure drop. This may cause material damage or loss of control on the bike.

2. Pressure check

**DANGER:** Underinflated tires are more likely to be punctured and make the ride more dangerous. The tire can slip from the rim on an uneven surface and move along the rim which can cause falls, collisions, or material damage. Always inflate the tires with optimal pressure.

**NOTE:** Most manufacturers use the psi unit to denominate pressure on the tire. To metricize, use the following table.

<b>Psi</b>	30	40	50	60	70	80	90	100	110	120	130	140
<b>Bar</b>	2,1	2,8	3,5	4,1	4,8	5,5	6,2	6,9	7,6	8,3	9,0	9,7

The optimal pressure can be found on the tire or in the provided rim instructions. The optimal pressure can usually be found on the side. If you have any trouble, contact the seller.

**NOTE:** The higher the weight of the rider, the more pressure is needed to inflate the tire.

Check the pressure with a pressure gauge (offered by the seller). If the pressure is too low, use a pump to pressurize it. If the pressure is too high, open the valve and let the air out. It is recommended to use a pressure pump with inbuilt gauge, so you can check the pressure while inflating the tire.

**NOTE:** There are several valve types: Schrader valve, Presta valve and Dunlop valve.



3. Inspecting the tire surface

Lift up and slowly spin both wheels. Check the side and the top of the tire. The tire's surface must be flat everywhere. There cannot be any bulging and the texture must be undisturbed. The material should not peel off or be damaged in any way. Check the rims also.

**INSPECTING THE SADDLE AND SEAT POST**

**DANGER:** If the seat post is not properly inserted into the frame, it can get loose and cause a fall, collision or material damage.

**1. Check that the seat post is firmly affixed to the frame.**

Grab the saddle and try to move it to the side. The saddle and seat post must not move in any way.

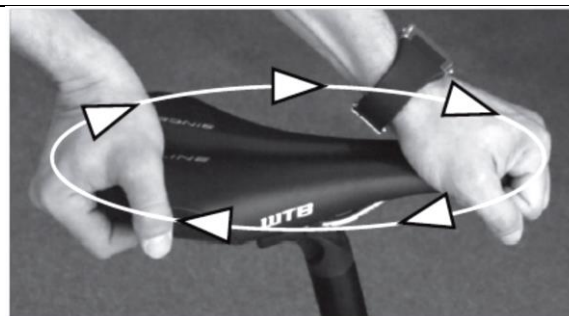

**2. Check that the saddle is affixed well to the seat post.**

Try to move the saddle up and down. The saddle cannot move.



If you have the KAWASAKI Kulture 20" model, check whether the screws are tightened correctly.

**INSPECTING THE STEM AND THE HANDLEBARS**

**DANGER:** The handlebars and the stem are incredibly important for your safety. Their damage or incorrect assembly can lead to serious injuries. If there is a problem with these parts of the bike or you're unsure, do not use the bike and consult an appropriate customer service.

Check the position of the stem and the handlebars with regard to other parts of the bike. The stem must be aligned with the front wheel rim and the handlebars must be at right angle. Grip the front wheel with both legs. Grab the handlebars and try to steer them sideways. Also try to move the handlebars inside the stem. None of the components should be loose and there shouldn't be any creaking.

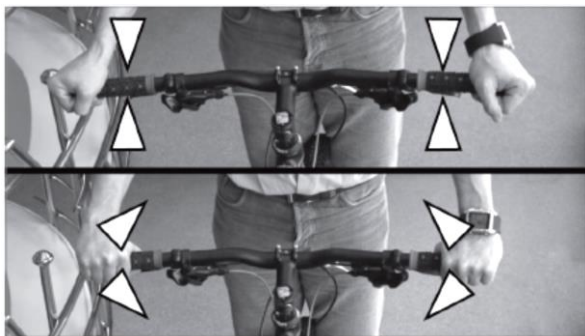

**INSPECTING THE HANDLEBAR ASSEMBLY**

Grip the front wheel with your legs. Make sure the brake levers are tightly attached and that the grips hold onto the handlebars. None of these components can twist or shift. There should be no strange sounds. If you decide to affix a bell to the handlebars, make sure it holds tightly and that you can easily reach for it while on the bike.

**INSPECTING THE HEAD SET**

If you want to inspect the head set, you must brake the front wheel (manually) and repeatedly move the bike front/back. There shouldn't be any noise and the connections should hold tightly. Then lift up the rear wheel above the rest and shift the front wheel so that it'll be at right angle to the frame. Once you loosen your hold on the handlebars, the front wheel should align with the frame again.



## INSPECTING THE BRAKE SYSTEM

**DANGER:** Defective brakes can endanger your life. Inspect the brakes carefully.

### 1. Inspecting brake pads/shoes

Firmly squeeze the brake levers so that the brake pads/shoes grip the rim/disc (the distance between the lever and the grip should be 35 mm). The wheels should be locked completely once you try to move them. The right lever brakes the rear wheel, the left brakes the front wheel.

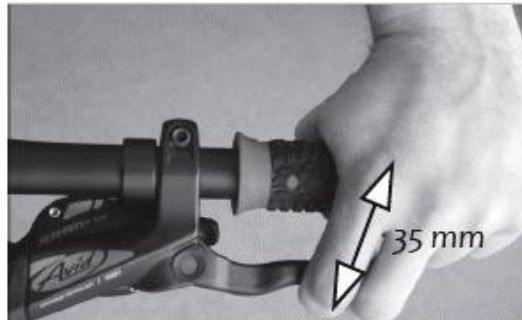

### 2. Inspecting rim brakes and cables

- It is important to keep the cables clean and in a good condition. The adjusting screws should be securing them tightly.
- Check the state of the screws by squeezing the braking levers – the range of movement should not be excessive (you should not be able to squeeze the levers fully).



The brakes are functioning correctly, if the entire brake shoe surface touches the rims when the lever is squeezed and if the brake shoes are in line with the rim. After releasing the lever, the distance between the rim and the brake shoe should be the same on both sides. If you have rim brakes, it is important to check the brake shoes regularly for wear. The brake shoes' rabbets mark maximum possible wear.

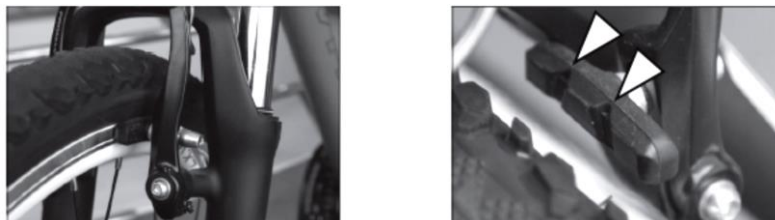

### 3. Inspecting coaster brakes

- You brake by back pedalling.
- Check if the brake arm is sufficiently tightened to the frame. You should not have to back pedal for more than ¼ spin. With drum brakes, visually check the cables and all components (the inner mechanism can be checked only by authorized professional).



#### 4. Inspecting hydraulic and disc brakes

**DANGER:** The brake system can fail completely if there is too much dirt on the brake discs. In such a case, carry out maintenance immediately.

**SCORCH RISK:** The discs may heat up if used intensively. If you touch them, you can suffer burns.

Check the brake caliper by trying to turn it in every direction. The caliper should hold tightly and should not be able to move in any direction.

- Check the brake lubricant by squeezing the brake levers with maximum force and then looking for any lubricant leakage.
- The brake discs cannot be bent, scratched or otherwise mechanically damaged.
- Check the brake disc – lift the wheel off the ground and spin it. It should spin silently and there should be no resistance.
- Check the brake discs/pads for wear (instructions above).

**NOTE:** The brake discs, pads and calipers can significantly wear during several-day rides. That's why it is recommended to bring spare calipers and pads with you. However, some skill and knowledge is required to replace these components. Consult the seller if necessary. If you feel you cannot replace these components by yourself, ask a qualified professional for help.

#### 5. Inspecting mechanical disc brakes

Checking the cables is described in point 2, checking the calipers in point 4.

### INSPECTING THE CRANKS AND THE CHAIN

1. Squeeze the cranks to the frame (as depicted). You should not be able to otherwise move them and they should not make any noise during a ride.
2. Don't forget to check the chain. It should be clean and the links cannot be deformed. When you spin the pedals back, the chain should move freely without falling off.



## ASSEMBLY, MAINTENANCE AND SETTINGS

### TOOLS/TECHNICAL SUPPORT

The bike was assembled in a manufacturing plant and later partly disassembled for easier transport. It is possible the bike was assembled again before purchase. It can also be sold disassembled in the original package. If you act according to the following instructions, you'll ensure the bike's longevity. Follow the instructions and check if you have all the parts and tools necessary to complete the assembly. Read the following chapters for detailed information about maintenance, settings, adjustments and lubrication of your bike. Contact us if you have any further questions or need additional spare parts.

### Tools needed for assembly:

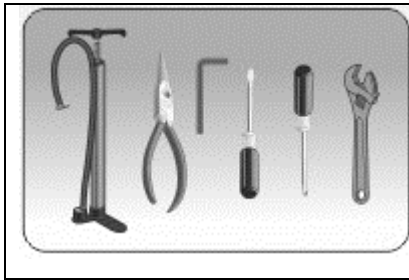

- Philips screw driver: 4 mm, 5 mm
- Allen wrench: 6 mm, 8 mm
- Screw-wrench or a nut wrench: 9 mm, 10 mm, 14 mm, 15 mm
- Wrench and socket wrench
- Pliers to cut wire

You'll avoid injuries only if the bike is correctly assembled and set. If you purchased an already set bike, it is recommended to check it according to the manual before using it. Make sure that the bike was supplied with all the necessary assembly and adjustment instructions.

### ASSEMBLY

Taking into account all the model varieties, this manual is generalized. Should you have a problem with the assembly, contact the customer service.

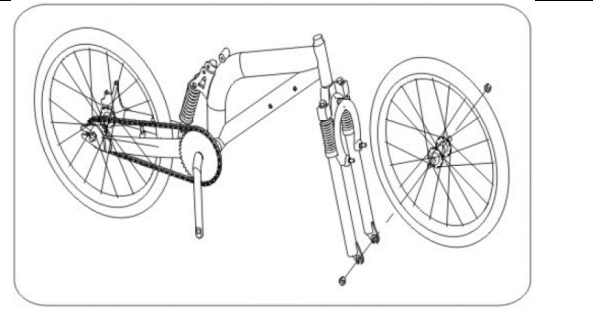
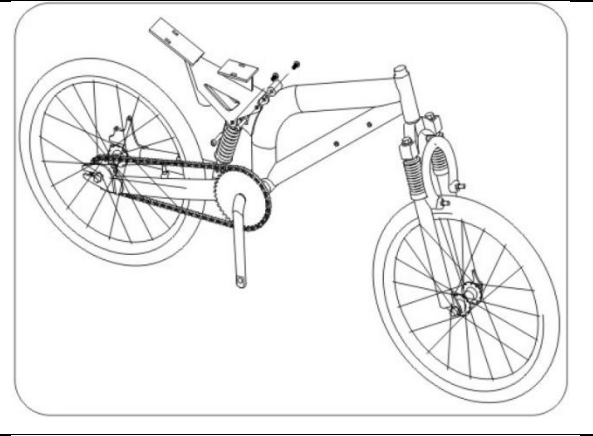
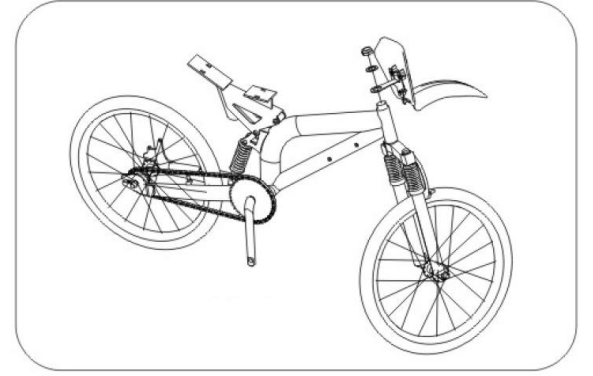
<ul style="list-style-type: none"><li>• Place the front wheel in the center of the fork and screw the nuts to the wheel with the supplied nut wrench.</li></ul>	
<ul style="list-style-type: none"><li>• Screw the bolts on the seat holder with the supplied Allen wrench.</li></ul>	
<ul style="list-style-type: none"><li>• Assemble the upper part of the headset, Slide the front mudguard onto the fork tube and then put the disassembled part of the headset back. Tighten with the supplied nut wrench.</li></ul>	

- Slide the handlebars into the steering tube so that they're aligned with the front fork and screw the expanding bolt with a wrench.

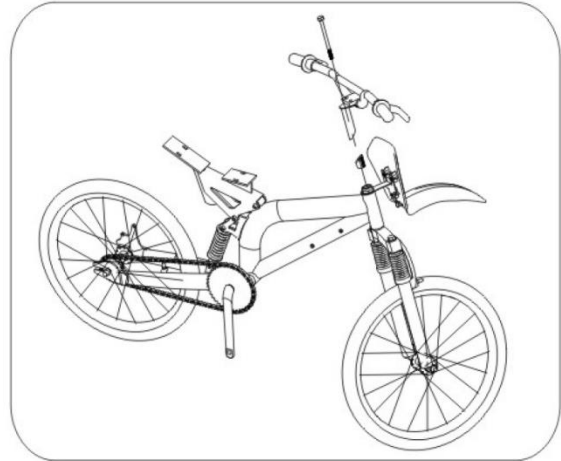

- Screw dowels into the lower frame tube.

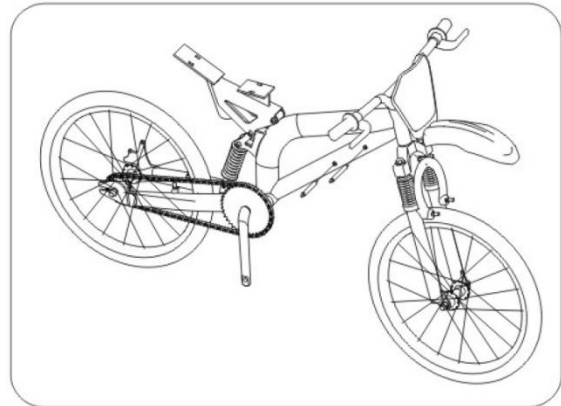

- Affix the saddle onto the saddle holder with bolts and nuts.

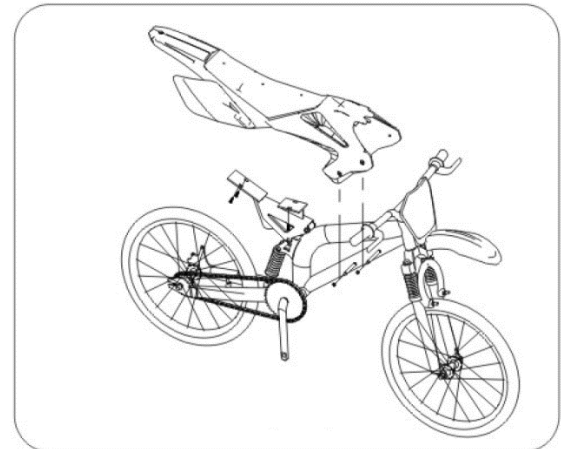

- Screw the right pedal (marked with R) to the right crank (the side with the chain). Screw clockwise. Then screw the left pedal (marked with L) to the left crank. Screw the left pedal anti-clockwise.

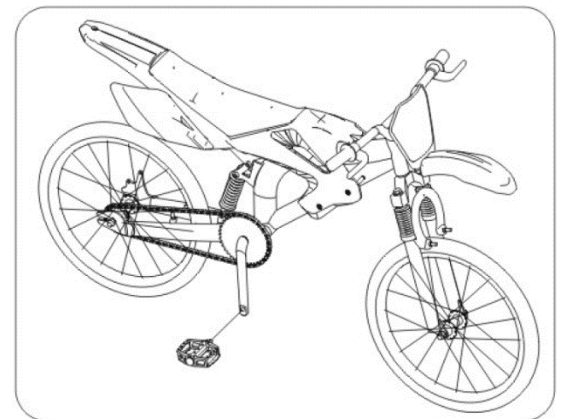

- Put the rear reflector to the hole in the rear mudguard and affix it with bolts.

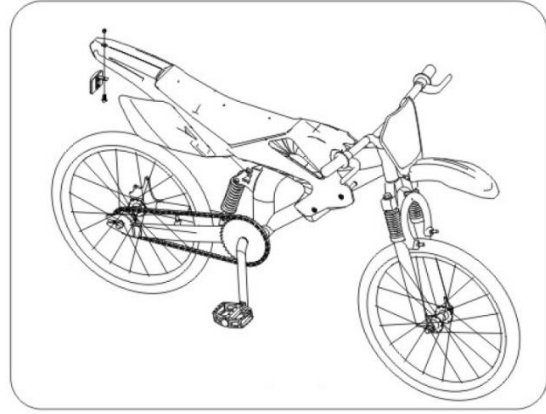

## SADDLE POSITION

It is not possible to adjust the seat height with some models.

### Choosing the right size:

Stand next to the assembled bike with legs astride at shoulder level.

The gap between the highest frame point (1) and the user's groin should be approx. 2.5 cm.

The user's legs should reach at least 2.5 cm above the highest point of the frame (3).

The rider needs to be able to reach the brake levers and use them comfortably (if they are a part of the bike).



## REFLECTORS

The bike is outfitted with reflectors. A front reflector (white), a rear reflector (red), two wheel reflectors (white) and two pedal reflectors (orange). Having reflectors on a bike is required by legislature and very important to your safety. They should be kept clean and properly affixed. Check the reflectors, holders and connections regularly. Replace any damaged components.

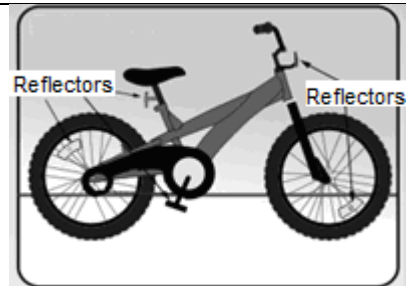



### INSTALLING THE FRONT REFLECTOR

**NOTE:** After assembling the bike, check the placement of the reflectors. The reflectors should always be vertical.

#### Installing reflector onto the handlebars:

Attach the holder with the white reflector so that the reflector faces straight ahead (A).

After setting the reflector's position, affix the holder with a fixing bolt – tighten with screwdriver.

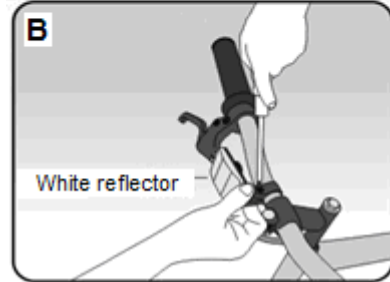
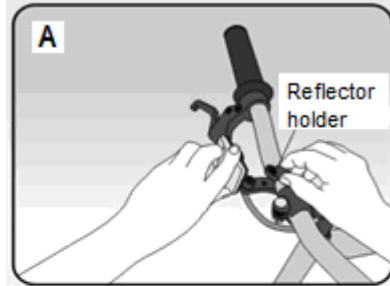

### INSTALLING THE REAR REFLECTOR

1. Loosen the screws on the rear reflector holder and set the reflector into the correct position.
2. The rear reflector must be vertical and facing backwards.
3. There should be at least 7.5 cm gap between the reflector and the edge of the saddle.

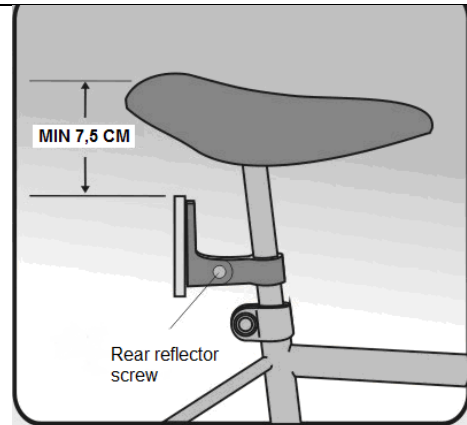

### Maintenance

**WARNING!** For your safety, do not use the bike if the reflectors are missing, damaged or not properly set. Make sure both rear and front reflectors are vertical. Be careful not to cover the reflectors with clothes or other materials. Keep the reflectors clean with the help of a soap and a wet cloth.

## PEDAL ASSEMBLY

The pedals are marked with L or R (left/right).

1. Screw the right pedal (R) clockwise to the right-side crank (the side with the chain).
2. Screw the left pedal (L) to the left-side crank.

**NOTE:** Screw the pedals manually first, so that you do not damage the thread. After tightening it with a wrench, make sure it is threaded fully. If the wrench is too thick, its range may be limited.

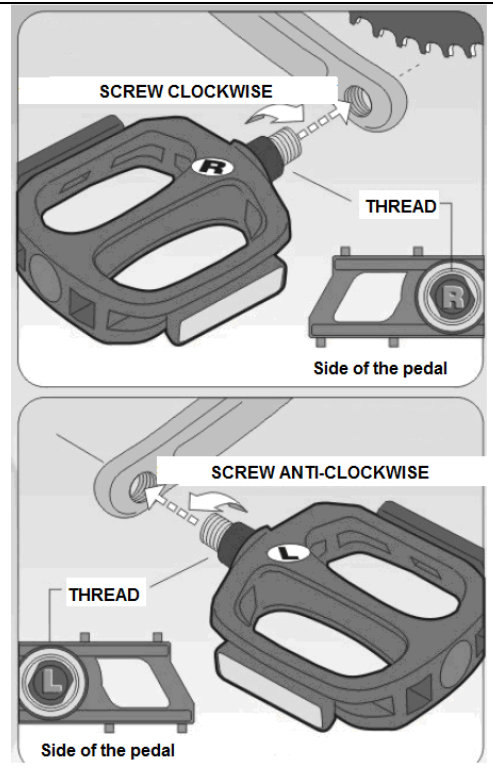

## SADDLE ASSEMBLY

- Insert the seat post onto the bike frame – the bent end upwards.
- NOTE:** Insert the seat post at least up to the minimum insertion point. If the point is not marked, insert at least 7.5 cm of the seat post.
- Tighten the seat post clamp – recommended torque = 13.6 N m.
  - Loosen the saddle clamp and attach the saddle to the seat post.
  - Tighten the saddle clamp – recommended torque = 17 N m.

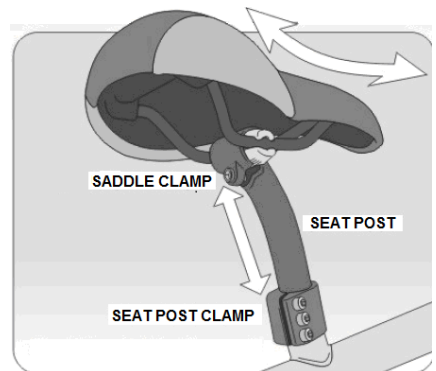

## SADDLE HEIGHT

1. Step on the pedal so that it is in its lowest position.
2. Put your heel onto the pedal, so that your foot is parallel to the ground.
3. Adjust the seat so that you can reach the ground with the toes of your other foot. The saddle should be parallel to the ground and aligned with the frame.
4. Tighten the seat post clamp – recommended torque = 17 N m.

**NOTE:** Insert the seat post at least up to the minimal insertion point.



### HORIZONTAL POSITION OF THE SADDLE

1. Step on the pedal so that it is in its lowest position.
2. Put your foot on the pedal parallel to the ground.
3. Adjust the saddle so that your knee and the pedal align in a vertical position to the ground. Some cyclists prefer to have the saddle a little more forward.

**NOTE:** The saddle should be parallel to the ground and aligned with the frame.

4. Tighten the saddle clamp fully.



### BRAKE AND BRAKE CABLE ASSEMBLY

1. Connect the cable to the brake lever – open the lever and insert the cable end.
2. Thread the cable through the adjustable bolt and safety nut. Tighten the safety nut.
3. Attach the brake to the fork with a screw and tighten it.
4. Pull on the cable until the brake pads are touching the rims and then tighten the brake screw.

Check that the brake pads are in contact and aligned with the rims.

See chapter about setting the brake system.

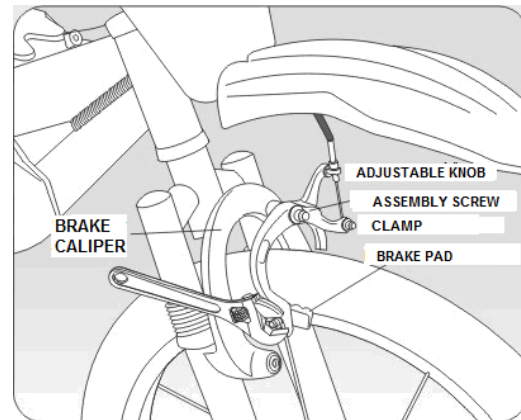
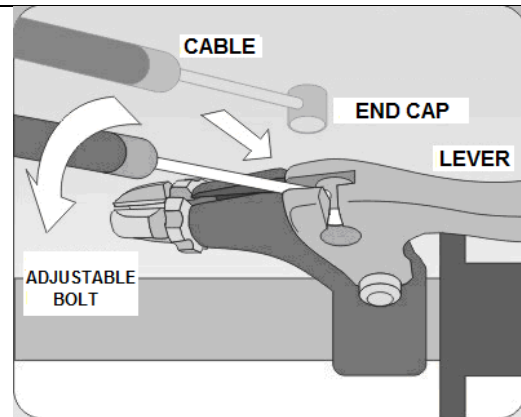

### STEM AND HEADSET ASSEMBLY (4 BOLTS)

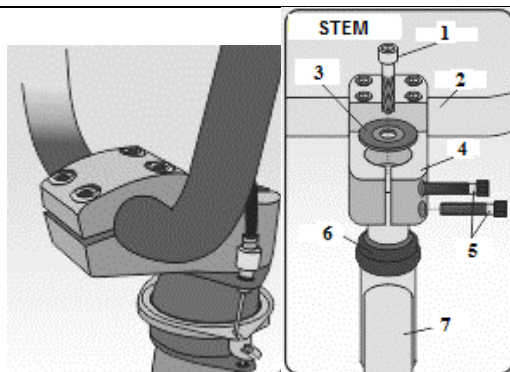

1. Compression bolt
2. Handlebars
3. Upper headset cover
4. Stem
5. Side bolts
6. Headset
7. Frame

**NOTE:** The headset and the stem are already assembled. It is necessary to adjust both parts at the same time.

1. To adjust the headset or the stem, loosen the side bolts first.
2. Adjust the stem so that it is aligned with the front wheel.
3. Tighten the compression bolt to affix the headset and the fork. If the fork cannot be freely moved, the bolt needs to be loosened.

**WARNING!** Do not tighten the compression bolt too much. Its purpose is to adjust the headset. The clamp screws affix the headset to the handlebars and the side bolts affix it to the fork.

4. Once the headset is adjusted, tighten both side bolts with 2.5 kg/mm (0.02 N m) torque. Make sure not to tighten them too much.

**WARNING!** Do not tighten too much the screws/bolts that affix the headset to the handlebars and the fork. It could have detrimental effect on the durability of the stem and the steering abilities of the bike, which could result in a fall and injury.

## STEM AND HANDLEBAR ASSEMBLY (1 BOLT)

**1. Affix the stem to the fork:** Thread a washer (5) through the bolt (4), insert it into the stem (1) and screw on the wedge.

Do not screw the bolt (4) into the wedge (2) for more than 4 turns. Turn the stem forwards, insert it onto the headset and adjust the height according to your preferences.

**WARNING!** Insert the stem at least to the min. insertion point. Otherwise, the stem may get damaged and a fall may occur.

Make sure the mark cannot be seen (is under the headset nut). Slightly tighten the bolt on the stem - just so the stem won't slide into the headset.

**2. Securing the handlebars onto the stem:** Slide the handlebars into the stem, set the stem to be aligned with the front wheel and secure the clamp bolt.

**3. Affixing the brake levers to handlebars:** Release the fixing bolt on the brake levers.

Shift the grip to the sides if necessary and put the levers onto the handlebars – the rear brake lever goes onto the right handlebar.

**4. Tighten the stem bolt and the brake fixing bolts:**

**WARNING!** Be careful not to tighten the bolts too much – you could damage the steering mechanism which could result in a fall.

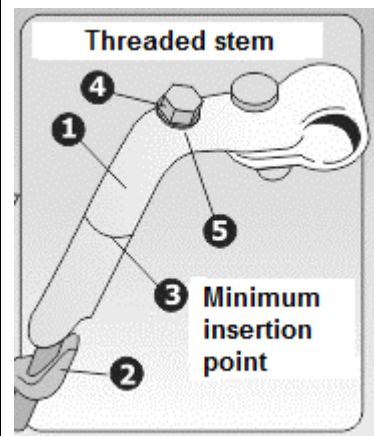

### Adjust the handlebar height:

**WARNING!** If the clamp isn't tightened properly, the handlebars could twist during the ride and you could fall off the bike.

Tighten the clamp bolt. If there are more bolts on the clamp, tighten them evenly.

**5. Make sure the stem is properly fixed:** Grip the front wheel with your legs and try to turn the handlebars. If you'll be able to move them without the front wheel turning, adjust the stem so that it is aligned with the front wheel again and tighten the bolt on the stem (max. half a turn).

Check the position, repeat the steps if necessary.

**6. Check if the handlebars are affixed correctly:** If the handlebars can be turned up/down, the bolt is not tightened enough. Return the handlebars to the initial position and tighten the bolt. If there are more bolts on the clamp, tighten them evenly.

Check the position, repeat the steps if necessary.

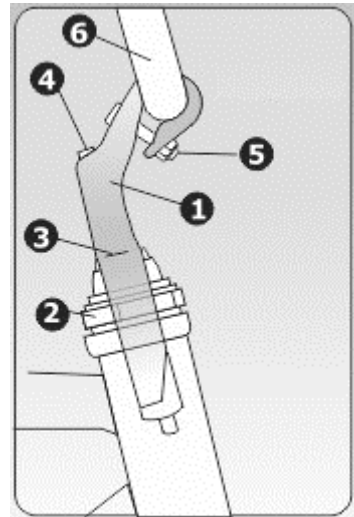

## AFFIXING THE FRONT WHEEL TO THE FORK

Put the fork and the wheel axle (1) together – make sure the axle is fully in the slots (2).

- Make sure the beaks of the safety washers (4) are inserted into the holes on the fork.

**NOTE:** Some models have a fork with the wheel retention system. The washers are not necessary in this case.

- Fix the wheel in the fork with two flange nuts (3).

**WARNING!** Do not use other nuts.

**NOTE:** The recommended torque is 28.5 N m.

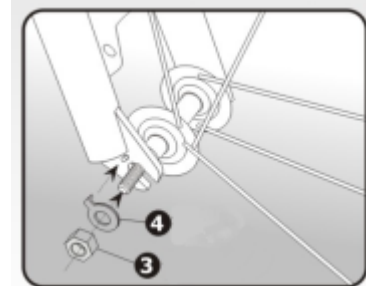
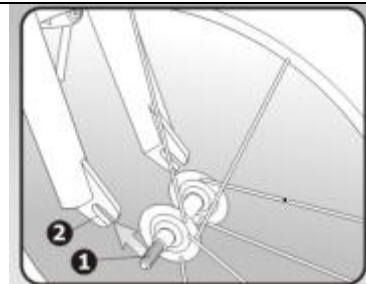

## BRAKE SYSTEM

### BRAKE SYSTEM SETTING

**WARNING!** Do not use the bike if the rear brake is not properly set.

#### 1. Set the brake pads into the correct position:

Release the nut on both brake pads. Adjust the pads so that they are aligned with the rim and touching it with their entire surface area. Make sure the pads do not grind against the tire. If there are arrow marks on the pads, they must point backwards. Tighten the nuts while holding the pads in place.

#### 2. Make sure the brake pads are secure:

Grip the brake pads and try to move them from their current position. If you are successful, repeat step 1, but tighten the nuts more. Try to move the pads again. Repeat these steps until the brake pads are firmly in place.

#### 3. Tightening the cable:

Press the brake pads onto the rim and loosen the fixing bolt (the bolt that secures the brake in the brake calipers). Tighten the cable and secure the bolt again.

**WARNING! Do not tighten the bolt too much. The cable could get severed which could lead to the rider falling during the ride and injuring themselves and or others.**

Squeeze the brake lever at least twenty times. Then press the brake pads with one hand to the rim and use the other to loosen the fixing bolt. Tighten the cable and secure the bolt again.

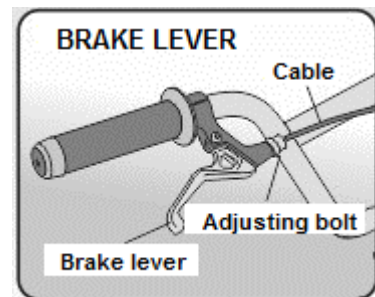
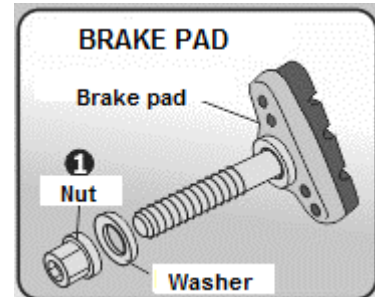

The following instructions describe the brake system setting necessary before the first ride. Make sure to inform yourself on the correct brake type.

**1. Check that the bolts/nuts on the calipers are tightened enough.**

Check the bolts and nuts on both brakes.

**2. Center the brake pad position:**

With V-brakes, loosen the fixing bolt (6) on the brake caliper (4) and adjust the calipers so that the distance between the rim (3) and both calipers is even. With caliper brakes, adjust the brake pads (2) with a spring. Make sure both ends are hooked to the inner side or the pins on the calipers. Squeeze the brake lever twice. If the distance between the rims and both calipers is not even, repeat this step.

**3. Setting the correct distance:**

The distance between the rim and the brake pad should be 0.1 – 0.2 cm. The distance is set with the adjusting bolt on the brake lever or the brake caliper. If it is not possible to set the distance correctly, press the rim and loosen the fixing bolt (6). Adjust the brake pads so that the distance between them and the rims is 0.1 – 0.2 cm. Then tighten the brake cable – be careful not to misalign the brake calipers. Finally, tighten the fixing bolt, squeeze the brake lever and check the brake function. Release the fixing nut if necessary, tighten/loosen the cable and tighten the bolt again.

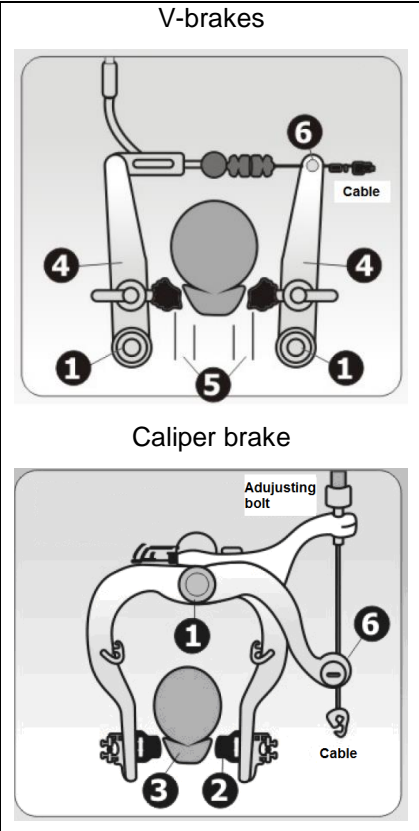

**WARNING! Do not tighten the bolt too much. The cable could get severed which could lead to the rider falling during the ride and injuring themselves or others.**

Repeat the steps if the distance between the rim and the calipers is not optimal. Do not forget to secure all the adjusting bolts with safety nuts.

**WARNING!** For safety reasons, do not adjust the brakes when the wheel is not centered. You could decrease the effectivity of the brake system. In this case, contact the customer service.

**4. Inspecting the Bowden cable:**

Make sure the Bowden cable is bound to the brake lever and the adjusting bolts. If this is not the case, repeat step 3.

**5. Make sure the clamp is secure:**

Squeeze the brake levers with maximum force and make sure the cable doesn't slide out of the clamp. If the cable is not fixed properly, repeat steps 3 and 4 and tighten the bolt more. Check again and repeat if necessary.

**6. Adjust the brake lever position on the handlebar:**

Adjust the brake lever distance with the adjusting bolt (if possible). The distance between the brake lever and the handlebar should not be more than 8 cm.

**7. Check the brake lever function:**

Squeeze the lever with maximum force. If the brake lever touches the handlebar, repeat steps 1 – 7.

**WARNING!** If repeating the steps does not help, contact the customer service.

**REDUCING THE NOISE IN CALIPER BRAKES:**

Caliper brakes may creak or make other noises during braking. This is usually not caused by defect. If you want to reduce the noise level, read the following instructions:

Make sure that the brake is correctly set. Use a wrench to adjust the brake pads into the correct position (the brake pad surface touches the rim fully).

**WARNING!** Be careful not to diverge the calipers too much. You could compromise the brake systems effectiveness.

## **BRAKE SYSTEM CONTROL**

### **Braking technique:**

The left brake lever controls the front brake; the right brake lever controls the rear brake. Squeeze the brake lever – the lever will pull the brake cable and the brake pads will grip the rim.

Squeeze the levers slowly and evenly to stop safely. To minimize the braking distance, always use both manual brakes.

**WARNING! If you do not adhere to the following instructions, you may sustain an injury or injure others.**

Adjust and check the brake system before using the bike for the first time (see Brake system setting). Learn how to brake at slow speed and on an even surface first.

The brake system is effective, if you use it correctly. If you brake too abruptly, you risk falling over the handlebars. Always use both brakes at the same time.

Try not to brake while making a turn. Slow down before riding on these kind of surfaces: wet surface, sand, gravel, leaves. Always use both brakes at the same time to avoid skidding.

If the rims are wet, the brake efficiency decreases and the braking distance is longer.

Be careful while riding downhill at great speed – the higher the speed, the higher the braking distance. For your safety, slow down before every turn.

Do not let the rims come into contact with wax, oil or other lubricants. Lubricants increase the braking distance and lower the brake efficiency.

If you register that the brake efficiency decreased, if you haven't been able to brake in time or if the brake lever touches the handlebars, inspect the brakes immediately and adjust them properly.



## ADJUSTING THE REAR DERAILLEUR

The lower limit adjusting screw controls the distance between the derailleur and the rear wheel, while the upper limit adjusting screw determines the caliper movement in regards to the frame.

1. Shift to the biggest gear and detach the rear derailleur cable by pulling it out of the cable anchor bolt. Put the chain onto the smallest sprocket-wheel.
2. Adjust the upper screw so that the chain is aligned with the smallest sprocket-wheel. Tighten the cable, attach it again and secure the limit cable anchor bolt.
3. Try to shift gear to every sprocket-wheel – the gear shifting should be smooth and quiet.

If an unusual noise is coming from the derailleur, gradually turn the cable anchor bolt clockwise to decrease the cable tension – this will allow for greater movement of the caliper outwards. If you turn the cable anchor bolt anti-clockwise, the cable tension will increase and the caliper range of movement in the direction of the wheel will also increase. This way you'll adjust the caliper position in regards to the cassette. Turn the cable anchor bolt in the direction you want the chain to be moved.

4. Shift the chain to the biggest sprocket-wheel and adjust the lower screw so that the chain and the biggest sprocket-wheel are aligned. If you are unable to shift the chain to the biggest sprocket-wheel, turn the lower screw clockwise to increase the chain range of movement in the direction of the wheel.
5. Try out the gear shifting on every wheel – it should be smooth and quiet.

**NOTE:** It is possible you'll need to repeat the above steps.

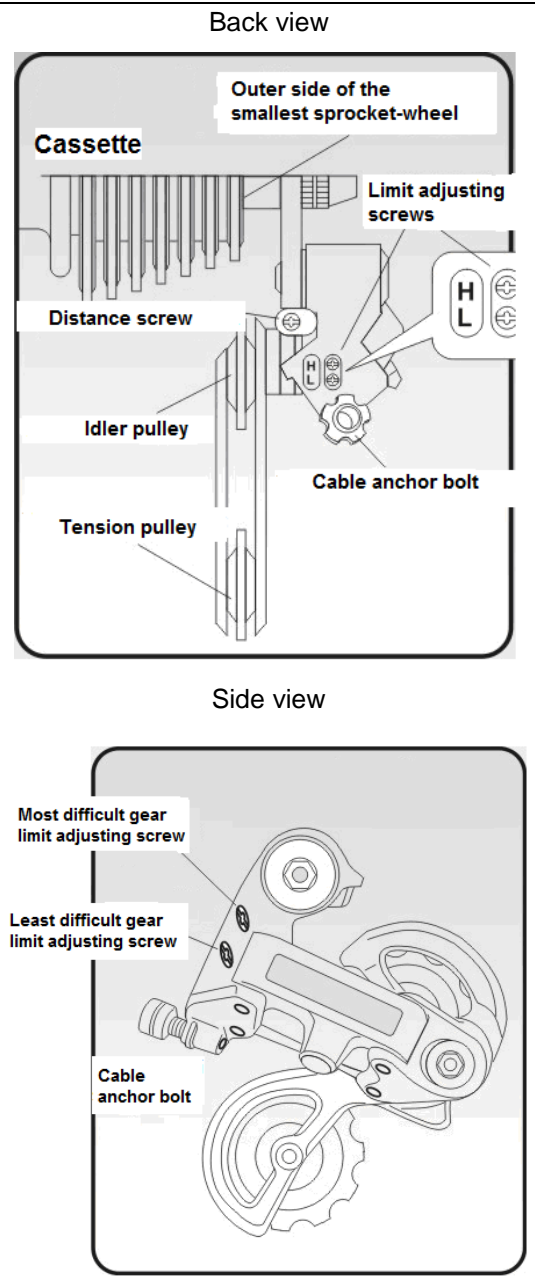

## CHAIN

The chain is one of the most used parts of the bike as it transfers the force from the pedal to the rear wheel. It is very important to keep the chain clean and lubricated. Clean the chain carefully before every lubrication. Sand and other small particles that get stuck to the chain can rapidly decrease its longevity. Proper and regular maintenance significantly prolongs the service life of the sprocket-wheels, chainrings and both derailleurs.

The chain tension on a bike with rear derailleur is regulated by a spring in the derailleur. If you have a bike without a rear derailleur, you can straighten the chain by shifting the rear wheel in the fork backwards. The chain's range of movement between the chainring and the sprocket-wheel should not be higher than the position of the chain.

Over time, the chain gets worn and it is necessary to replace it. If you do not replace the chain in a timely manner, a damage to the chainring or the sprocket-wheel might occur (teeth deformation). It is important that you let a qualified professional measure the chain regularly, ideally every 700 – 1000 km.

If you want access to the chain, you must remove its cover. With some models, it is necessary to remove the right pedal or crank as well, in order to remove it.

## SHOCK ABSORBER WITH STEEL SPRING

Turn the grooved ring left until the spring is released and then push the spring in. If the ring cannot be moved, grab the spring with your hand and turn it along with the ring.

Turn the adjusting ring again, this time one turn right – this way you'll tighten the spring. Maximum tension is reached after 4 – 6 turns from this point. If you turn the adjusting ring to this point, the spring coils will touch, which can damage the rear shock-absorber or it's dropout. If you want to increase the spring tension, turn the adjusting ring right.

Adjust the spring tension so that after sitting on the saddle the decline will be 10 – 30% of total spring rate.

To determine the total spring rate, measure the distance between the center of the rear wheel quick release hub and the lower side of the saddle. If the shock-absorber gives more than 1/3 of the total spring rate after sitting down even after tightening the spring with 6 turns, you need to use a spring with higher density. While replacing the spring, keep in mind that the length of the spring needs to be adjusted to the total rear shock absorber suspension.

## TIRES

### INFLATING THE TIRES

The tires are inflated through a valve (which can be used to release air also). The most common valves are the Shreder and Presta valves. Choose the pressure gauge adapter according to the valve type.

**Shreder valves** are used mainly on car tires. It is necessary to unscrew the valve cap first and connect then connect the valve with a tube or a pressure gauge adapter. To release the air, press on the pin inside the valve. To press the pin, use a key or something similar.

**Schreder**

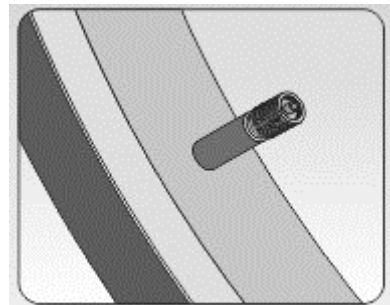

**Presta valves** have a smaller diameter and can be found especially in tubeless tires. To inflate tires with the Presta valve follow these instructions: Unscrew the valve cap, release the safety on the valve end (screw anti-clockwise) and press the valve to make sure it is free. Attach the air pump and start pumping.

**Presta**

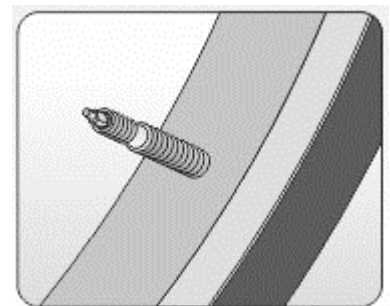

If you use a compressor on a gas station: Attach a tube with Presta type adapter (the tube can be bought in any bicycle store). Attach the other end of the tube to the compressor.

To release air from the tire, release the safety and press on the valve.

After inflating the tire, do not forget to tighten the safety again.

## TIRE REPLACEMENT

1. Release air from the tire: Press on the pin inside the valve.

2. Press the tire from both sides and force the tire heel out of the rim. Use this method to release the entire tire.
3. Stand the bike on the handlebars. Turn the wheel so that the valve points downwards and grab the tire from the above. Try to drag the tire over the entire rim.
4. Use appropriate tools or at least 2 spoons with a curved grip to release the heel from the rim. Be careful not to pinch the tube between the heel and your tools. Once the tire is released from the rim by at least  $\frac{1}{4}$ , you should be able to release the rest manually.
5. Release the side of the tire from the rim and then release the tube between the rim and the tire – except the part with the valve.
6. It should be easy to release the other side of the tire. Start directly opposite the valve and simply drag the entire tire over the rim.

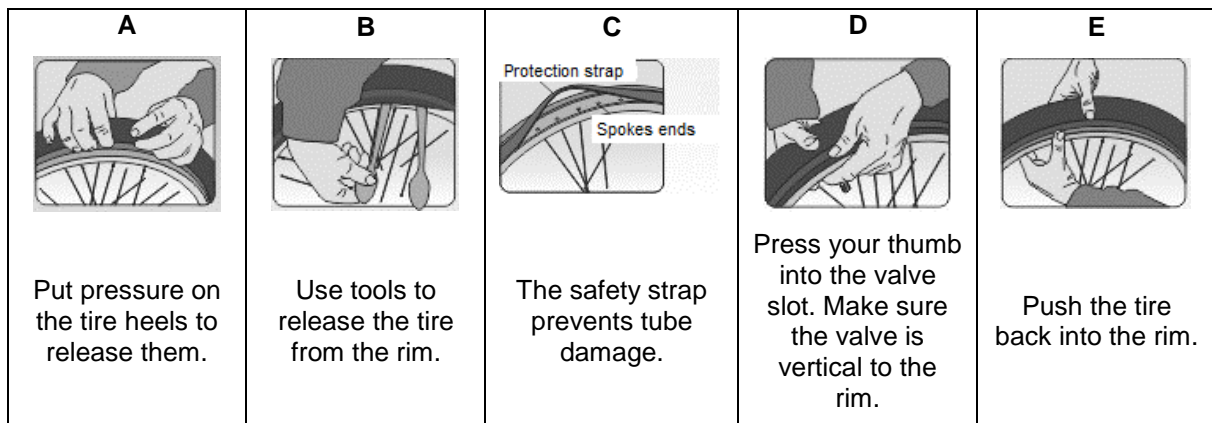

## TRAINING WHEELS

If your bike has training wheels, they can either be delivered assembled or disassembled. It depends on the model of the bike.

### Package contents for disassembled training wheels:

- 2 x long bolt
- 6 x washer
- 2 x lock washer
- 2 x nut
- 2 x safety nut (nut with plastic washer)

### Training wheel assembly:

1. Thread first a washer, then the wheel and then another washer from the other side of the wheel.
2. Screw the nut on the bolt so that the wheel can spin freely.
3. Insert the wheel with the bolt into the circular hole on the steel strut – the wheel must be on the outer side of the strut.
4. Thread the lock washer and another nut through the bolt and secure the wheel to the strut. Use the safety nut with plastic washer.
5. Use two wrenches and tighten both nuts against each other. Make sure that the wheel spins freely without diverging,
6. Repeat the steps with the second wheel.

## AFFIXING THE TRAINING WHEELS ONTO THE BIKE

**Caution:** Do not remove the nut that keeps the rear wheel in the frame.

The rear wheel axle is tightened and secured by jam nuts. Affixing/removing the training wheels does not affect their setting.

### Affixing the training wheels (Fig. 1):

1. Unscrew the nuts (4) from the rear wheel axle.
2. Assemble the mug guard (3, optional). Do not disassemble the stabilizers (1).
3. Assemble the following components from first to last: wheel arms (2) mud guard (3).
4. Set the training wheels so that there would be a 25 mm gap between the wheels and the ground (Fig. 2). Tightening force = 17 N m.
5. **CAUTION:** A children's bike with training wheels can only be used on flat surfaces and under adult supervision. For a bike with training wheels, columns and doorways present a problem, because the wheels can get stuck. If the child rides with training wheels on an uneven terrain or gets caught on an obstacle, the bike can turn over and the child may get injured.

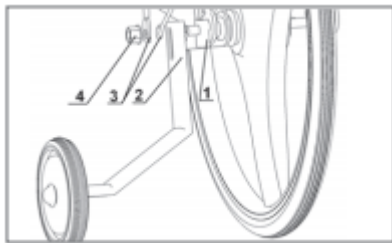

Fig. 1 – Training wheel assembly

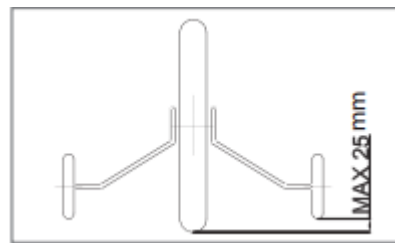

Fig. 2 – Minimum distance of the wheels from the ground.

**Important:** Make sure that the bolts are sufficiently tightened before every ride.

If you do not want to use the training wheels, thread a washer through the rear wheel axle and affix a cap nut (nut with closed end) to cover the dangerous edges of the uncovered bolt.

## REPAIRS AND MAINTENANCE

**WARNING!** Check the bike often and regularly. Damage or incorrect setting/adjustments can lead to injuries. Make sure the bike is assembled and adjusted according to this manual.

**If a component is damaged, misplaced or worn, do not use the bike until the component is replaced.**

Check that all connections are tightened according to this manual. A loose part can affect the control you have over the bike and can get easily lost. You can damage the components by tightening them too much. While replacing any components, make sure they are compatible.

If the bike frame is made of aluminium, it is necessary to inspect it regularly. There can appear small cracks on the frame as a result of overloading, strong shocks, etc. If the cracks appear on your bike, stop using the bike and request a frame appraisal from the customer service.

**NOTE:** If you are not sure how to adjust or repair the bike correctly or you do not have sufficient tools, contact an authorized service.

## SPROCKET-WHEEL/CHAIN

**Maintenance:** The chain must be correctly strung. If the chain is too tight, the pedalling will be more difficult. If the chain is too loose, it will fall off the sprocket-wheel.

**WARNING!** You cannot ride a bike with fallen chain.

Correct chain tension (1): The range of movement of the chain in regards to the straight line (3) should be 1.27 cm (2).

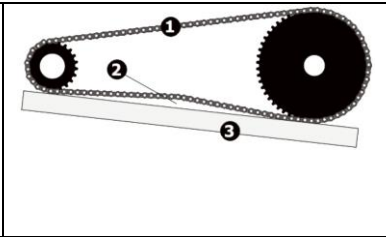

## TIRES

Check the air pressure in the tires regularly, because over time the air escapes in small amounts. If the bike is in storage for a longer time, it shouldn't stand on wheels.

**WARNING!** Do not use the bike if the rear or front wheel is not properly inflated. You could damage the tube. Do not use a compressor without pressure gauge. You may over pressurize the tube/tire and cause it to rupture.

Use either manual or foot air pump. Only use a compressor if it has a pressure gauge. The recommended pressure can be found on the side of the tires.

Before inflating a tire, make sure that the distance between the tire bead and the rim is the same everywhere. If the tire is not inserted correctly, let air out of the tube to easily insert the tire bead to the problematic part of the rim. Often check the pressure and the position of the tire during inflating. The pressure in the tire should correspond with the value marked on the side of the tire. **If the tire is worn or damaged, replace it immediately.**

## WHEELS

**Checking the wheel condition:** Try to keep both wheels in good shape. Good maintenance affects the brake efficiency and bike safety and stability. Be careful during the following instances:

- **Dirty or oily rims**

**Important:** The brake system's effectivity is compromised. Do not use wax- and oil-based cleaning products. Clean the rims with a clean cloth and soap water, then wash them with water and let them dry. Do not use the bike until the rims are completely dry. Be careful not to accidentally get lubricant onto the rims.

- **Rim deformation**

**Check the rim condition:** Lift the wheel up, make it spin and watch if it diverges. In case of deformation, it is recommended to take the bike to an authorized service.

- **Lost or broken spoke**

Make sure that all the spokes are tightened and none are damaged or missing.

**Important:** If you ride with damaged/missing spokes, you can lose balance and fall. It is recommended to take the bike to an authorized service.

- **Loose headset bearing**

Check the bearings condition. Lift the wheel up and try to move it sideways.

**Important:** If the fork moves inside the headset, it is necessary to set it properly before ride.

- **Loose nut**

Makes sure all the nuts are secure before every ride.

## BEARINGS

**Maintenance:** Check the bearings regularly. Bearings lubrication and maintenance should be carried out only by qualified professionals at least once a year or in case of any problems with the bearings.

**Checking the headset bearings:** The fork should be able to turn smoothly. The fork should not move inside the headset if the front wheel is lifted.

**Checking the crank bearings:** The cranks should be able to turn freely and smoothly. Also check the fixation of the derailleur. The pedals should not be able to move inside the cranks.

**Checking the wheel bearings:** Lift the wheel up and make it spin.

If the wheel spins easily without any resistance, the bearings are in good condition. If the wheel is not spinning and you nudge it slightly, the weight of the reflector should propel it forwards/backwards. The wheel should not be able to move sideways.

## LUBRICATION

**WARNING! Lubricate evenly. If the lubricant gets into the rim or brake pad, the braking efficiency will decrease, the braking distance will be longer and you could injure yourself or others.**

You should not neglect to lubricate the chain regularly – you'll prevent corrosion and ensure that the rear derailleur is in proper working order. It is recommended to use a petroleum jelly provided by the seller.

Pay attention to all moving parts of the bike and lubricate them if necessary. Car and motorcycle lubrication oils are not meant to be used on a bicycle.

It is best to lubricate the chain in the evening so that the lubricant has time to seep into the entire chain. Clean off the excessive lubricant in the morning so that debris doesn't stick to the chain.

Regularly check and clean the suspension forks and rear suspension units. The ideal interval is about every 50 hours of use. Check the bike after every ride in extreme conditions (water, mud). You'll prevent permanent fork or rear suspension unit damage. Do not forget to clean the hub sealing caps, even from the inside.

Do not lubricate the derailleurs too much. If there is too much lubricant, the debris will stick to them which is detrimental to their efficiency.

If there is too much lubricant on the chain, it can get onto the rims. Wipe the excess lubricant off of the chain.

Prevent oil from getting onto the pedals.

Clean the excess oil on the rims, brake pads, pedals and tires with warm water and soap. Wash the component with water and let it dry.

Lubrication of the Bowden cables, head set, centre lock bearings and pedals should be carried out by a qualified professional. It is necessary to disassemble these components before cleaning and lubrication. After that, they need to be assembled and set again.

Lubricate the components with industrial oil according to the following instructions:

COMPONENT	INTERVAL	TECHNIQUE
Brake levers	Once per 6 months	Put one drop of oil on each brake lever at the anchor point.
Caliper brakes	Once per 6 months	Put one drop of oil on the brake anchor.
Brake cables	Once per 6 months	Put 4 drops of oil on each end of the brake cable and let them trickle down the cable.
Pedals	Once per 6 months	Put 4 drops of oil on the pedal thread.
Chain	Once per 6 months	Put one drop of oil on each chain link. Wipe off the excess oil.

## ONE-PIECE CRANKS

To regulate the movement of a one-piece crankset, release the left safety nut by screwing clockwise and tighten the regulation bearings cover with a screwdriver by screwing anti-clockwise. To adjust the range of movement properly, tighten the safety nut – screw anti-clockwise.

1. Take the chain off.
2. Unscrew the left pedal clockwise.
3. Unscrew the left safety nut anti-clockwise and fold the safety washer.
4. Unscrew the regulation cover bearings with a screwdriver.
5. Remove the left bearing, slide the cranks out of the frame (to the right side) and remove the right bearing. Clean the bearings and the contact surfaces; replace the component if necessary. Lubricate the bearings with oil and assemble the crankset again.

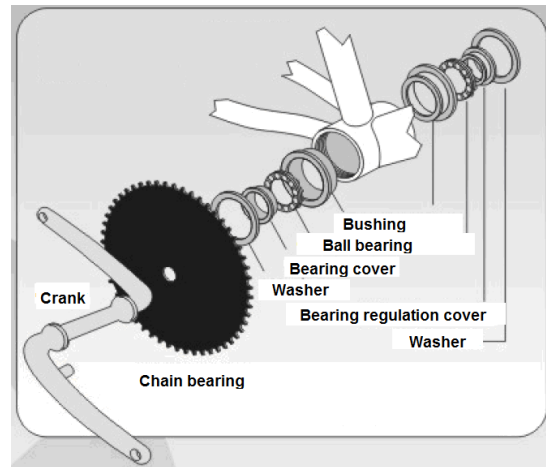

## CLEANING AND MAINTENANCE

**DANGER:** The bike's components can be weakened by corrosion, which can lead to dangerous situations and the risk of an injury or material damage.

Corrosion could be caused by:

- Salt (spreadings during winter)
- Salt in the air (seaside and industrial locations)
- Sweat

**NOTE:** Do not expose any of the components to extreme temperatures. Even noncorrosive materials can be affected.

**WARNING:** Do not use steam cleaners. The high pressure steam can damage the bike.

Proper maintenance can significantly prolong the service life of the bike and its components. That's why you should not neglect to clean it regularly.

Clean rough debris by a stream of water. Let the bike dry for a while and apply a cleaning product (only use products especially made for bicycles and make sure that you do not damage the coating or the rubber, plastic or metal components). Wash the product off with water and let the bike dry.

Clean the chain using appropriate cleaning product or a suitable cleaning kit (consult the seller if necessary). If you do not have a chain cleaning kit available, put a small amount of alcohol-free cleaning product onto a dry cloth and clean the chain. While cleaning, slowly turn the cranks backwards. Then lubricate the chain links with appropriate lubricant. If you apply too much of the lubricant, it can get onto other components, such as rims. This can decrease the efficiency of the braking system and cause falls or material damage.

**NOTE:** Clean and lubricate the chain after every ride in moist environment, every longer ride on sand or every 200 km.

**Maintenance schedule:**

Maintenance	Standard use	Frequent sports/professional use, etc.
Regular check-up	Every 200 km or every two months (depends on what comes first)	Every 100 km or once a month (depends on what comes first)
Interval between check-ups	Every 200 km / once a year	Every 500 km / every two months.
Brake pads/shoes check-up	Every 400 km	Every 100 km
Brake disc check-up	Every 500 km	Every 250 km
Chain wear check-up	After an accident	After an accident
Replacing the handlebars and seat post	As per producer's instructions or after the minimum of 5 years	As per producer's instructions or after the minimum of 2 years

**STORAGE**

**WARNING:** The material could be damaged. Improper storage conditions can damage the tires and bearings or cause corrosion.

**Recommended:**

- Clean and maintain the bike as per instructions in the corresponding chapter.
- Store the bike in dry and dust-free conditions.
- Only use racks compatible with your bike. Consult the appropriate rack types with the seller if necessary.
- If you store the bike so that one or both wheels are on the ground:
  - Spin the wheel several times every 2 – 3 months.
  - Turn the handlebars in both directions.
  - Spin the cranks backwards several times.

**TORQUE OF THE CONNECTING MATERIALS**

Component	Attached to	Connecting material	Torque
Seat post	Saddle	1 x screw M7/8	22 – 25 N m
	Main frame	2 x screw M5	5 – 7 N m
2 x screw M6		7 – 9 N m	
		6 – 8 N m	
Stem	Handlebars 31, 8 mm	2 screws	6 – 9 N m
		4 screws	4.5 N m
	Handlebars 25,4 mm	2 screws	7 – 9 N m
		4 screws	4.5 N m
	On head tube	1 screws	19 – 20 N m
	In head tube	1 screw M8"	18 N m
2 screws		9 N m	
Front derailleur	Frame		5 N m



	Cable		5 N m
Rear derailleur	Frame		7 – 9 N m
	Cable		5 N m
	Chain wheel		3 N m
Gear shifting levers	Handlebars		4.5 N m
Brake levers	Handlebars		5.9 N m
Disc brakes	Hub	6 screws	4 – 6 N m
		Central lock	40 N m
Caliper brake	Fork		9 – 10 N m
	Frame		5 – 7 N m
V-brake	Fork/frame		5 – 9 N m
	Cable		6 – 8 N m
	Brake calipers		5 – 8 N m
Central set	Frame	Inner bearing	25 – 30 N m
		Outer bearing	40 N m
Crank arm	Central tube set	Bottom bracket Octalink	32 – 44 N m
		Bottom bracket PowerSpline	35 – 54 N m
Chainring	On the crank arm		8 – 11 N m
Pedal axle	In the crank arm		30 N m

The table presents only recommended values – the exact torque should be specified by the producer. Tightening the connecting material requires certain skillset and tools. If you are unexperienced in this area or don't have the required tools, contact the seller.

**CAUTION:** Always use the maximum torque marked on the component. Never use a bigger amount of force. The values in the table should not replace the values set by the manufacturer.

Be careful not to damage carbon components. Each part should have the maximum torque marked somewhere on the body of the component. If the recommended amount of torque is small, use specialized micro-granulated petroleum jelly which helps to sufficiently tighten the connections even by lesser force with minimum risk of damage. If you register any damage on the carbon components (cracks, deep striations or other damage), do not use them and replace them immediately.

## RIDING RECOMMENDATIONS

- The maximum user weight limit for 12", 14" and 16" bikes is 40 kg. The total maximum weight limit (bike + rider + baggage) cannot be higher than 50 kg. Check the particular bike's specifications.
- The maximum user weight limit for 12", 14" and 16" bikes is 90 kg. The total maximum weight limit (bike + rider + baggage) cannot be higher than 100 kg. Check the particular bike's specifications.
- Before using the bike for the first time, check the brakes, tire pressure, handlebar height and seat adjustment (according to the rider's height). Also check if the connections are properly tightened.
- If you are using the bike on public roads, you must be equipped in accordance with the local legislation.

- If you are using the bike in worsened visibility conditions or at night, the bike must be outfitted with reflective features, lights and rear red reflector.
- Brake with both brakes at the same time.
- Do not use the bike in worsened visibility conditions or a bad weather if you are not equipped to handle it.
- It is not recommended to use the biggest sprocket-wheel along with the smallest chainring and vice versa.
- Shift gears while riding and do not put too much force into pedalling.
- Clean the chain and chain links regularly with a soft brush, because a bigger amount of debris on the chain can cause untimely wear. Apply suitable lubricant regularly (for these parts use silicon oil, not petroleum jelly).
- While riding on public roads, the user must abide by the local legislature.

**IMPORTANT:** On public roads, the rider must be always equipped in accordance with the local legislature (helmet, knee and elbow protectors). The children must be instructed by their parents or guardians about handling the bike correctly.

## SERIAL NUMBER

WRITE YOUR SERIAL NUMBER HERE: \_\_\_\_\_

Keep this manual so that you have the serial number in case of emergency.

### SERIAL NUMBER LOCATION

**Underside view:**

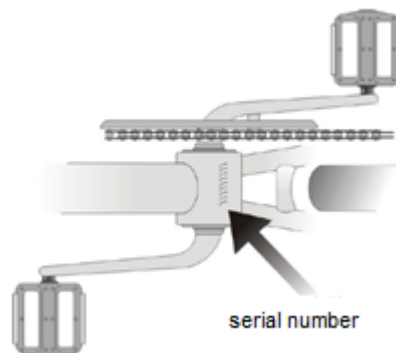

## TERMS AND CONDITIONS OF WARRANTY, WARRANTY CLAIMS

### General Conditions of Warranty and Definition of Terms

All Warranty Conditions stated hereunder determine Warranty Coverage and Warranty Claim Procedure. Conditions of Warranty and Warranty Claims are governed by Act No. 40/1964 Coll. Civil Code, Act No. 513/1991 Coll., Commercial Code, and Act No. 634/1992 Coll., Consumer Protection Act, as amended, also in cases that are not specified by these Warranty rules.

The seller is SEVEN SPORT s.r.o. with its registered office in Borivojova Street 35/878, Prague 13000, Company Registration Number: 26847264, registered in the Trade Register at Regional Court in Prague, Section C, Insert No. 116888.

According to valid legal regulations it depends whether the Buyer is the End Customer or not.

“The Buyer who is the End Customer” or simply the “End Customer” is the legal entity that does not conclude and execute the Contract in order to run or promote his own trade or business activities.

“The Buyer who is not the End Customer” is a Businessman that buys Goods or uses services for the purpose of using the Goods or services for his own business activities. The Buyer conforms to the General Purchase Agreement and business conditions to the extent specified in the Commercial Code.

These Conditions of Warranty and Warranty Claims are an integral part of every Purchase Agreement made between the Seller and the Buyer. All Warranty Conditions are valid and binding, unless otherwise specified in the Purchase Agreement, in the Amendment to this Contract or in another written agreement.

### **Warranty Conditions**

#### **Warranty Period**

The Seller provides the Buyer a 24 months Warranty for Goods Quality, unless otherwise specified in the Certificate of Warranty, Invoice, Bill of Delivery or other documents related to the Goods. The legal warranty period provided to the Consumer is not affected.

By the Warranty for Goods Quality, the Seller guarantees that the delivered Goods shall be, for a certain period of time, suitable for regular or contracted use, and that the Goods shall maintain its regular or contracted features.

#### **The Warranty does not cover defects resulting from (if applicable):**

- User's fault, i.e. product damage caused by unqualified repair work, improper assembly, insufficient insertion of seat post into frame, insufficient tightening of pedals and cranks
- Improper maintenance
- Mechanical damages
- Regular use (e.g. wearing out of rubber and plastic parts, moving mechanisms, joints etc.)
- Unavoidable event, natural disaster
- Adjustments made by unqualified person
- Improper maintenance, improper placement, damages caused by low or high temperature, water, inappropriate pressure, shocks, intentional changes in design or construction etc.

### **Warranty Claim Procedure**

The Buyer is obliged to check the Goods delivered by the Seller immediately after taking the responsibility for the Goods and its damages, i.e. immediately after its delivery. The Buyer must check the Goods so that he discovers all the defects that can be discovered by such check.

When making a Warranty Claim the Buyer is obliged, on request of the Seller, to prove the purchase and validity of the claim by the Invoice or Bill of Delivery that includes the product's serial number, or eventually by the documents without the serial number. If the Buyer does not prove the validity of the Warranty Claim by these documents, the Seller has the right to reject the Warranty Claim.

If the Buyer gives notice of a defect that is not covered by the Warranty (e.g. in the case that the Warranty Conditions were not fulfilled or in the case of reporting the defect by mistake etc.), the Seller is eligible to require a compensation for all the costs arising from the repair. The cost shall be calculated according to the valid price list of services and transport costs.

If the Seller finds out (by testing) that the product is not damaged, the Warranty Claim is not accepted. The Seller reserves the right to claim a compensation for costs arising from the false Warranty Claim.

In case the Buyer makes a claim about the Goods that is legally covered by the Warranty provided by the Seller, the Seller shall fix the reported defects by means of repair or by the exchange of the damaged part or product for a new one. Based on the agreement of the Buyer, the Seller has the right to exchange the defected Goods for a fully compatible Goods of the same or better technical characteristics. The Seller is entitled to choose the form of the Warranty Claim Procedures described in this paragraph.

The Seller shall settle the Warranty Claim within 30 days after the delivery of the defective Goods, unless a longer period has been agreed upon. The day when the repaired or exchanged Goods is handed over to the Buyer is considered to be the day of the Warranty Claim settlement. When the Seller is not able to settle the Warranty Claim within the agreed period due to the specific nature of the Goods defect, he and the Buyer shall make an agreement about an alternative solution. In case such agreement is not made, the Seller is obliged to provide the Buyer with a financial compensation in the form of a refund.



**SEVEN SPORT s.r.o.**

Registered Office: Borivojova 35/878, 130 00 Praha 3, Czech Republic  
Headquarters: Delnicka 957, 749 01 Vitkov, Czech Republic  
Warranty & Service Centre: Cermenska 486, 749 01 Vitkov, Czech Republic  
CRN: 26847264  
VAT ID: CZ26847264  
Phone: +420 556 300 970  
E-mail: eshop@insportline.cz  
reklamace@insportline.cz  
servis@insportline.cz  
Web: www.insportline.cz

---

**SK**

**INSPORTLINE s.r.o.**

Headquarters, Warranty & Service centre: Elektricka 6471, 911 01 Trencin, Slovakia  
CRN: 36311723  
VAT ID: SK2020177082  
Phone: +421(0)326 526 701  
E-mail: objednavky@insportline.sk  
reklamacie@insportline.sk  
servis@insportline.sk  
Web: www.insportline.sk

Date of Sale:

Stamp and Signature of Seller: